



- SPOTTER
- DENT PULLER
- MIG
- PLASMA
- INDUCTION
- LIFT
- RIVETING
- ACCESSORIES



INVEST IN THE FUTURE



French manufacturer
since 1964

Car Body Welding Systems

Catalogue Carrosserie

Catalogo Carrozzeria

Karosserie-Schweißtechnik Katalog

Catálogo de Soldadura para Carrocería

2
0
2
2





GYS FRANCE
Laval

🕒 1964
👥 × 600

Created in 1964, GYS is a French industrial group with 850 employees around the world. Built around continuous investment in Research & Development and in the acquisition of knowledge, the company is now a major player in the design and manufacture of welding machines, battery chargers and car body repair equipment.

“ The market realities are constantly changing and the size of our family business requires us to quickly adapt to new contexts and new challenges.

We are convinced that our future is closely linked to the future of our partners. This is why we do everything in our power to understand what distributors and users expect from us and what challenges they face every day. To support them in facing these challenges, we wish to become and remain their privileged partner on the path we will travel together. ”

Bruno Bouygues,
C.E.O.



Nicolas & Bruno Bouygues

A worldwide coverage

125 countries



visit with
📺 Youtube

INVEST IN THE FUTURE

FR

Créé en 1964, GYS est un groupe industriel français regroupant plus de 850 collaborateurs dans le monde. Fort d'un centre de recherche de premier plan, GYS est un acteur majeur dans la conception et la fabrication d'équipements de soudage, de chargeurs de batteries et de systèmes de réparation carrosserie.

Les nouvelles réalités du marché sont en perpétuel changement et la taille de notre entreprise familiale nous impose une adaptation rapide aux nouveaux contextes et à leurs enjeux.

Nous sommes convaincus que notre avenir est étroitement lié à celui de nos clients. Pour cela, nous mettons tout en oeuvre pour comprendre ce que les distributeurs et les utilisateurs attendent de nous, savoir à quels défis ils font face et voir dans quelle mesure nous pouvons leur permettre de les relever afin de devenir et rester leur partenaire privilégié pour le chemin que nous avons à parcourir ensemble.

DE

GYS wurde 1964 gegründet und ist ein französisches Familienunternehmen mit mehr als 850 Mitarbeitern auf der ganzen Welt. Dank einem erstklassigen Forschungszentrum ist GYS ein wichtiger Akteur in der Entwicklung und Herstellung von Schweißgeräten, Batterieladegeräten und Karosseriereparatursystemen.

Neue Marktbedingungen sind in fortwährender Veränderung und die Größe unseres Familienunternehmens veranlasst eine rasche Anpassung an neue Umstände und an ihre Herausforderungen.

Wir sind überzeugt, dass unsere Zukunft eng mit der unserer Kunden verbunden ist. Dafür setzen wir all unser Können ein, um zu verstehen, was die Händler und Anwender von uns erwarten, welchen Herausforderungen sie gegenüberstehen und um zu schauen, in welchem Maße wir sie unterstützen können, damit wir ihr bevorzugter Partner werden und bleiben auf dem Weg, den wir gemeinsam beschreiten.

IT

Nato nel 1964, GYS è un gruppo industriale francese che raggruppa oltre 850 collaboratori nel mondo. Forte di un centro di ricerca di grande importanza, GYS è uno dei maggiori protagonisti nella progettazione e fabbricazione di apparecchiature per la saldatura e il taglio, di cariche batterie booster e avviatori e sistemi di riparazione delle carrozzerie.

Le realtà del mercato sono in continuo cambiamento e richiedono risposte immediate. Le dimensioni della nostra impresa familiare consentono un adattamento rapido ai nuovi contesti e alle loro problematiche.

Siamo convinti che il nostro futuro sia strettamente legato a quello dei nostri clienti. Per questo noi mettiamo il massimo impegno per capire quello che i distributori e i loro clienti/utilizzatori si aspettano da noi, quali sfide devono affrontare e come possiamo aiutarli per farli crescere, per diventare e restare loro partner di riferimento per proseguire insieme sul cammino del successo.

👥
850 people

🏠
55 000 m²
590 000 sqf
2 factories

🇩🇪 GYS GERMANY
Aachen

🕒 2006
👥 × 70

🇬🇧 GYS U.K.
Rugby

🕒 2008
👥 × 35

🇨🇳 GYS CHINA
Shanghai

🕒 2004
👥 × 130

🇮🇹 GYS ITALIA
Venezia

🕒 2015
👥 × 15

Partners





GYS ACADEMY

Training centre dedicated to professionals

Centre de formation agréé

Trainingcenter für Profis

Centro di formazione dedicato ai professionisti

Ref. 52 53 0068153

3 catalogues

2700+ references



Welding & Cutting



Car body Welding Systems



Chargers, Boosters & Starters

DENT PULLING



GYS POT
p.6

Accessories,
levelling bars
p.16



Workstations
p.20



Pulling systems
p.26

Paintless repair
p.32

MOBILE PNEUMATIC LIFT



SPOT LIFT
p.34



AUTO ROLL
& accessories
p.34



ERGO LIFT
& accessories
p.36



TROLLEY IW1
p.37

SPOT WELDING

Overview
p.38

Traditional



PORTASPOT
p.40



GYS POT 32D
p.40

Inverter



GYS POT 100R
p.41



GYS POT BP & PTI
p.42

X & C Arms
p.44

Genius



GYS POT G
p.46

G Arms
p.50

Consumables
& accessories
p.51

RIVETING



GYS PRESS
p.52

Accessories
& consumables
p.56

MIG WELDING



GYS AUTO
p.62



MULTIPEARL
p.64



AUTOPULSE
p.66

Helmets, accessories
& consumables
p.70

INDUCTION



GYS DUCTION
COMBIDUCTION
p.78



POWERDUCTION
p.80

PLASMA



CUTTER & EASYCUT
p.84

+ MORE

Windscreen repair p.86

Bumper repair p.88

Tools p.90

Dust vacuum p.95 **NEW**

Working lights p.96

Working supports p.98

Safety protections p.100

CHARGERS & BSU



GYS FLASH & MORE
p.102

Advanced
R&D

85



Metal work
Tôlerie
Blechbearbeitung



Painting & marking
Peinture & marquage
Lackierstraße



Electronics
Électronique
Elektronik



Mechanical
Mécanique
CNC-Bearbeitung



Transformers
Transformateurs
Transformatoren



Cable work
Filerie
Kabelkonfektionierung

Assembly
Montage/tests
Montage

100%
in house
production

www.gys.fr





GYSPOT

DENT PULLING

ACIER / STEEL / STAHL

- ▽ Étoiles - Stars - Ausbeulstern
- ⌋ Anneaux - Rings - Zugösen
- 〰 Filis ondulés - Wavy wires - Wellendraht
- ⏏ Rabattage d'impact - Impact shrinking - Glätten

OPTIONS

Consommables - Consumables p.10

Chariots - Trolleys p.20

- ▽ Étoiles - Stars - Ausbeulstern
- ⌋ Anneaux - Rings - Zugösen
- 〰 Filis ondulés - Wavy wires - Wellendraht
- ⏏ Rabattage d'impact - Impact shrinking - Glätten
- + Rétreinte - Tempering - Temperieren

NEW



FIXED GUN

FIXED GUN

GYSPOT 2600

2600 A x1 **AUTOMATIC**

230V • 1~

052208

included

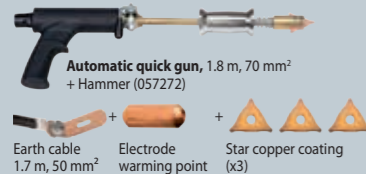

Automatic quick gun, 1.8 m, 70 mm²
+ Hammer (057272)

Earth cable 1.7 m, 50 mm² Electrode warming point Star copper coating (x3)

GYSPOT 2700

2600 A x1 **MANUAL**

230V • 1~

055353

included

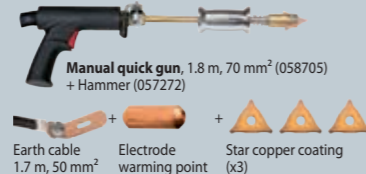

Manual quick gun, 1.8 m, 70 mm² (058705)
+ Hammer (057272)

Earth cable 1.7 m, 50 mm² Electrode warming point Star copper coating (x3)

GYSPOT 34.02 & 34.04

3500 A x1 **MANUAL**

230V • 1~

GYSPOT 34.02
065741

NEW

400V • 2~

GYSPOT 34.04
067943

NEW

included

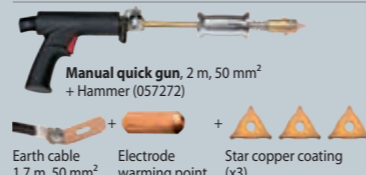

Manual quick gun, 2 m, 50 mm²
+ Hammer (057272)

Earth cable 1.7 m, 50 mm² Electrode warming point Star copper coating (x3)

QUICK GUNS

Quick & Easy

AUTOMATIC



WITH CONNECTOR
2 m, Ø 70 mm²
included 39.02/04
057517



WITH CONNECTOR
3 m, Ø 50 mm²
included PRO 230/400
057500

WITH CONNECTOR
3 m, Ø 70 mm²
included EXPERT 200/230/400
059207

MANUAL



WITH CONNECTOR
cable 2 m, Ø 70 mm²
included PRO 230/400,
EXPERT 200/230/400,
COMBI 230EPRO
057524

included electrode warming point:

No connector
cable 1.8 m, Ø 70 mm²
for 2700
058705

PATENTS REGISTERED NUMBERS
001830845-0001
EUROPEAN TRADEMARK & DESIGN

- ▽ Étoiles - Stars - Ausbeulstern
- ⌋ Anneaux - Rings - Zugösen
- 〰 Filis ondulés - Wavy wires - Wellendraht
- ⏏ Rabattage d'impact - Impact shrinking - Glätten
- + Rétreinte - Tempering - Temperieren
- + ⌋ Rivets - Rivets - Nieten
- + ⌋ Rondelles - Rings - Unterlegscheiben
- + ⌋ Goujons - Studs - Gewindebolzen

SYNERGIC CONTROL

PATENTS REGISTERED NUMBERS
EUROPEAN TRADEMARK & DESIGN



EXPERT SYNERGIC & MANUAL CONTROL

Welding current adjustment Welding time adjustment



GUN WITH CONNECTOR

GYSPOT 39.02 & 39.04

3800 A x1 **AUTOMATIC**

230V • 1~

GYSPOT 39.02
052215

400V • 2~

GYSPOT 39.04
052222

included



Automatic quick gun, 2 m, 70 mm² (057517)
+ Hammer (057272)

Earth cable 2 m, 70 mm² SPOTTER BOX STANDARD (053915)
(Details p.10)

GYSPOT PRO 230 & PRO 400

3800 A x2 **AUTOMATIC**

230V • 1~

GYSPOT PRO 230
052178

400V • 2~

GYSPOT PRO 400
052185

included



Automatic quick gun, 3 m, 50 mm² (057500)
+ Hammer (057272)

Manual quick gun, 2 m, 70 mm² (057524)

Earth cable 2 m, 70 mm² SPOTTER BOX PRO (050075)
(Details p.10)

GYSPOT EXPERT 200, 230 & 400

3800-4500 A x2 **AUTOMATIC**

230V • 1~

GYSPOT EXPERT 230
066885

NEW

200-240V • 1~

GYSPOT EXPERT 200
058842

ideal

400V • 2~

GYSPOT EXPERT 400
058859

included



Automatic quick gun, 3 m, 70 mm² (059207)
+ Hammer (057272)

Manual quick gun, 2 m, 70 mm² (057524)

Earth cable Thick 3 mm²
2 m, 70 mm² SPOTTER BOX PRO (050075)
(Details p.10)

	G NORM 62135	50/60 Hz	I ₂ max A	U ₂ V	I _{AM} A	I _{RMS} A	kW	OK	OK	MANUAL	SYNERGIC	AUTOMATIC	MANUAL	SEPARATE CABLE GUN	cm	kg
MADE IN GYS CHINA	GYSPOT 2600	230V	2 m	2600	5,4	16	1800	10	OK	—	—	—	—	—	20 x 32 x 18	15
	GYSPOT 2700	230V	2 m	2600	5,4	16	1800	10	OK	—	—	—	—	—	20 x 32 x 18	14,5
	GYSPOT 34.02	230V	2 m	3500	7,4	16	2500	20	OK	OK	—	—	—	—	22,5 x 36 x 23,5	21
	GYSPOT 34.04	400V, 2ph	4 m	3500	7,4	16	2500	20	OK	OK	—	—	—	—	22,5 x 36 x 23,5	21
MADE IN FRANCE	GYSPOT 39.02	230V	4 m	3800	7,4	16	2800	20	OK	OK	—	—	—	—	22,5 x 36 x 23,5	22
	GYSPOT 39.04	400V, 2ph	4 m	3800	7,4	16	2800	20	OK	OK	—	—	—	—	22,5 x 36 x 23,5	22
	GYSPOT PRO 230	230V	8 m	3800	7,4	16	2800	20	OK	OK	—	—	—	—	22,5 x 36 x 23,5	20,5
	GYSPOT PRO 400	400V, 2ph	8 m	3800	7,4	16	2800	20	OK	OK	—	—	—	—	22,5 x 36 x 23,5	20,5
	GYSPOT EXPERT 200	200-240V	8 m	4350-5100	7,2-8,7	30(D)	3100-3600	25-36	OK	OK	—	—	—	—	22,5 x 36 x 23,5	24,5
	GYSPOT EXPERT 230	230V	8 m	3800	7,4	16	2800	20	OK	OK	—	—	—	—	22,5 x 36 x 23,5	20,5
	GYSPOT EXPERT 400	400V, 2ph	8 m	4500	7,4	16(D)	3200	25	OK	OK	—	—	—	—	22,5 x 36 x 23,5	22,5



GYSPOT ALU

DENT PULLING ALU



FV FLEXIBLE VOLTAGE
85 V — 265 V
110 V — 230 V
100 m



SYNERGIC CONTROL PATENTS REGISTERED NUMBERS EUROPEAN TRADEMARK & DESIGN

Alu

890

Goujons - Studs

Acier / Steel / Stahl

3 H

TOOLS SELECT

- ▼ Étoiles - Stars
- ⌋ Anneaux - Rings
- 〰 Filis ondulés - Wavy wires
- ⌋ Rabattage d'Impact - Impact shrinking
- ↘ Rétreinte - Tempering
- T Rivets - Rivets
- Rondelles - Rings
- ⌋ Goujons - Studs

FIXED GUN

GYSPOT ALU PRO FV

100 · 230V · 1~
7500 A x1 AUTOMATIC
FV

021990
included
 Automatic alu gun 3 m, 25 mm²
 ALU BOX STANDARD (050020) (Details p.11)

ALU GUN

AUTOMATIC

3 m, Ø 25 mm²
included ALU PRO FV & COMBI 230 E.PRO



(x 3) 065635

66 mF CAPACITOR DISCHARGE WELDING

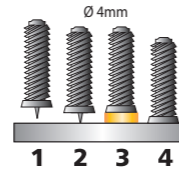

Joint rings for mandrel Ø 4/5/6 x 2 060814

PATENTS REGISTERED NUMBERS 002446450-0001 EUROPEAN TRADEMARK & DESIGN

OPTIONS



GYSPOT COMBI



DENT PULLING ALU + ACIER / STEEL / STAHL

9

3 GUNS INCLUDED



GUN WITH CONNECTOR

GYSPOT COMBI 230 E.PRO

230V · 1~
3800 A Acier / Steel / Stahl x3 AUTOMATIC
7500 A Alu x3 MANUAL

021266
included
 Manual quick gun, 2 m, 70 mm² (057524) + Automatic alu gun, 3 m, 25 mm²
 Earth cable 2 m, 70 mm² + SPOTTER BOX PRO (050075) (Details p.10) + ALU BOX STANDARD (050020) (Details p.11)

GYSPOT

ALU + STEEL DENT PULLING

MADE IN FRANCE 62135	50/60 Hz	I ₂ max A	U ₂ V	I _{RMS} A	I _{RMS} A	kW	MANUAL	SYNERGIC	AUTOMATIC	MANUAL	SEPARATE CABLE GUN	3 m	Included Alu box	21 x 24 x 36	12.5
GYSPOT ALU PRO FV	110 · 230V	2 m	7500	50 · 200	5	0.65	OK	OK	■	■	—	3 m	Included Alu box	21 x 24 x 36	12.5
GYSPOT COMBI 230 E.PRO	230V	8 m	3800 (steel) 7500 (alu)	7,4 (steel) 50 · 200 (alu)	16	2800 (steel)	20	OK	OK	—	■	2/3 m	Included Spotter box + Alu box	45 x 43 x 29	42.5



GYSPOT ARC PULL

DRAWN ARC

DENT PULLING

ALU + ACIER / STEEL / STAHL



SYNERGIC

EXPERT Control

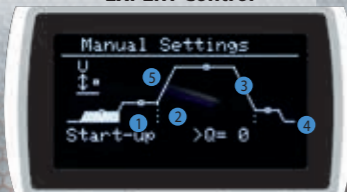
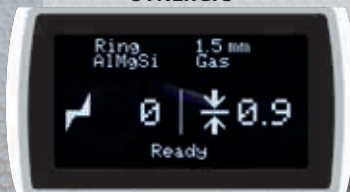

- Anneaux - Rings - Zugösen
- Goujons - Studs - Gewindebolzen
- Tiges inox - Stainless steel nails - Edelstahlnägel
- 1 Amorce - Start-up - Zündung
- 2 Décapage - Scouring (I & t) - Abbeizen
- 3 Arc (I & t) - Arc - Lichtbogen
- 4 Accroche - Hitching (I & t) - Verklebung
- 5 Hauteur - Height - Höhe

MANUAL



7 languages
FR, EN, DE, SP, IT, NL & RU

PFC POWER FACTOR CORRECTION

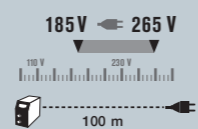

FV FLEXIBLE VOLTAGE

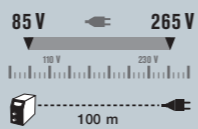

SR SECONDARY REGULATION

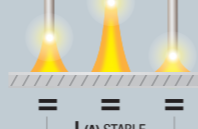

AD ANTI-DUST



SPECIAL TEARING RIVETS

Spécial arrachage de rivets - Spezial-Zugnieten

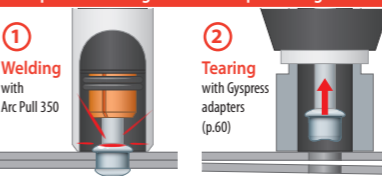

NEW



∅ max
Alu: 6 mm
Fe: 5 mm



∅ max
Alu/Fe: 8 mm



∅ max
Alu: 8 mm
Fe: 12 mm

SYNERGIC DIGITAL GUNS

UNIQUE Linear Motor

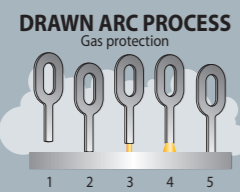

FULL CONTROL



Consumables for Gun
x2 059627
x1 059610



Ideal all position

GYSPOT ARC PULL 200

100 · 230V · 1~
200 A x1 MANUAL
FV SR AD
057470
included

- Manual synergic gun 3 m, 25 mm²
- ALU RING BOX 1.5 mm (AlSpec + AlMg3 + AlMgSi) 059429
- Lifting rod 180 mm (x3)

OPTIONS



GYSPOT ARC PULL 350

208 · 240V · 1~
350 A x1 MANUAL
PFC SR AD
062191
included



PACKS ARC PULL 350	Arc Pull 350	Croco T400.70 043787	Rivet box 064584	Alu ring box 1.5 mm 059429	Lifting rods 059610	Lifting rods 050792
					x1	180, 300, 500 mm
					x1	180, 300, 500 mm

GYSPOT ARC PULL 700

380 · 480V · 3~
680 A x1 MANUAL
SR IP 23
068315
included

- Manual synergic gun 3 m, 50 mm²
- Double earth clamps 700 A, 3 m, 50 mm² 068605
- ALU RING BOX 1.5 mm (AlSpec + AlMg3 + AlMgSi) 059429
- Arc Pull Rivet Box 700
- Lifting rod 180 mm (x1)
- Gas protection (x1) 068346
- Threaded studs holder ∅ 6 (x1) 068391, ∅ 8 (x1) 068407

MADE IN FRANCE 60974-1	50/60 Hz	I ₂ A	SYNERGIC	TECHNOLOGY		U ₂		kW	cm	ArcPull	ArcPull + gun		
				Acier/Steel	Alu	V	A						
GYSPOT ARC PULL 200	110 · 230V	6 m	10 · 100 (110 V) 10 · 200 (230 V)	Manual + Digital Gun Motion Control	—	20.4 · 24 V (110 V) 20.4 · 28 V (230 V)	16	2.4 (110 V) 5.6 (230 V)	OK	OK	20.5 x 25 x 33	8.6 kg	11.9 kg
GYSPOT ARC PULL 350	208 · 240V	6 m	10 · 350	Manual + Digital Gun Motion Control	—	20.4 · 34 V	16	1.9	OK	OK	30 x 24.5 x 22	11 kg	14.3 kg
GYSPOT ARC PULL 700	3x 400 V 3x 480 V	6 m	10 · 680	Manual + Digital Gun Motion Control	—	20.4 · 44 V	20 A (D) 16 A (D)	35 kW	OK	OK	32 x 32.4 x 41	16 kg	19.3 kg



FAST DENT PULLING



ACIER / STEEL / STAHL

EASY TOOL CONNECTION

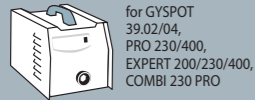

for GYSPT
39.02/04,
PRO 230/400,
EXPERT 200/230/400,
COMBI 230 PRO

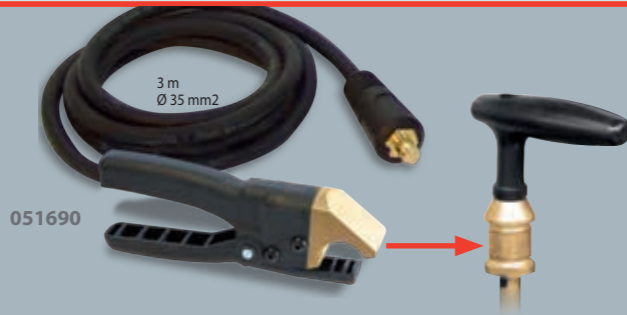

051690

3 m
Ø 35 mm²

 051584 380 g	 Anneaux - Rings - Anschweißösen 051652	 Fils ondulés - Wavy wires - Wellendraht 051669	 Rétreinte - Tempering - Glättwerkzeug 051676	 EASYGUN 051317	 Box of 3 electrodes for accessories 052822	 Poignée de tirage manuel 057289
---------------------	---	---	---	-----------------------	---	---

MANUSPOT =

050679

+

Tools set & support
for SPOT 600, 800, 1000, 1600,
Workstation & Dentstation

+
EASYGUN
051317

+
MANLINER
050471

3 m
Ø 35 mm²

PATENTS REGISTERED NUMBERS
001652108-0003
EUROPEAN TRADEMARK & DESIGN

MANLINER/GUN

056831

Adaptateur pistolet
- Gun adapter
included
052499

4 positions
4 Positionen

PATENTS REGISTERED NUMBERS
001652108-0003
EUROPEAN TRADEMARK & DESIGN

Direct impact electrodes (x5)
050839

Patins - Pads (x2)
060807

FAST & EASY



RINGMATIC

052154

included
(x 50)

Option
Adaptateur
pistolet - Gun
adapter
052499

LAMPE LIGNE DROITE

- Straight line lamp
- Dentline-laser

056770

QUICK SPOT AIR GUN V2

057340

LIGHT
920 g

2,5 m

AIR

SPOT ROTATE

Pneumatic

QUICK SPOT AIR GUN V2 + Mini-fraiseuse - Mini-Druckluftfräser

065567

057340 + 063228

Included
Tungsten drill Ø 6 mm
054172

Adaptateur pistolet - Gun adapter
052826

ALU

ARC PULLER PREMIUM

065161

ULTRA RESISTANT
No deformation

Full rotation
GRIP

Multi positions

NEW
Patins - Pads (x2)
069008

Included
Alu 3
065178

Included
Alu 4
065185

ALU PULLER

051003

4 positions
4 Positionen

Mini Puller
050921

Patins - Pads (x2)
060807

+ Included
Alu 1
050938

+ Included
Alu 2
050945

ANNEAUX DE TIRAGE RAPIDE

- Fast pulling rings

058743

x5
058712

goujons alu
- alu screws
Ø 4, 5 & 6 mm

+ Alu 1
050938

+ Alu 2
050945

Marteau à inertie
380 g
050051

MARTEAUX ALU

- Alu hammers

020986

ALU

ASPIRATEUR PNEUMATIQUE POUR POUSSIÈRES ALUMINIUM (ATEX)

- Pneumatic alu dust atex vacuum cleaner

058866

Capacity : 25 l
Working air pressure : 6 bar
Air consumption at 6 bar : 800 l/min
Suction connection : 50 mm
Max suction capacity : 150 m³/h
Max vacuum level : 2000 mm H₂O
Recommended compressor power : 7.5 HP
↳ 74 x 45 x 45 mm
▲ 18 kg

included
Filtre -
Filter
058873

included
Sac - Bag
5 kg
058880

5 m
Output Ø 29 mm
Input Ø 35 mm

 Décapeur thermique - Heat gun - Heißluftpistole I : 100/300°C (450 W) II : 300/650°C (1500 W) Air flow : 450 l/min 066311	 Pistolet à air chaud autonome à gaz - Gas hot air gun 060777	 Lampe à souder - Blow torch - Lötlampe 052741	 Novacet + (Butane/propane/ propylene) 380 ml/220 g HIGH QUALITY 040441	 Brosses - Brushes - Bürsten - Brossen - Cepillos Inox - Stainless - Edelstahl 044258	 Crayon marqueur thermique - Thermal marking pencil 121°C / 250°F 052765	 Thermomètre infrarouge - Infrared Thermometer -50 / +380 °C -58 / +716°F 052994	 Spray refroidisseur - Freezer spray -50 °C 400 ml (x 12) 048898	 Spray barrière thermique - Heat barrier spray 054325
---	---	--	---	--	---	---	--	--

MARTEAUX INERTIE
- Slide hammers - Ausbeulhammer

COMPLETE
057272



Clous - Nails - Nägel



Rondelles - Washers - Ringe



COMPLETE KIT
051225

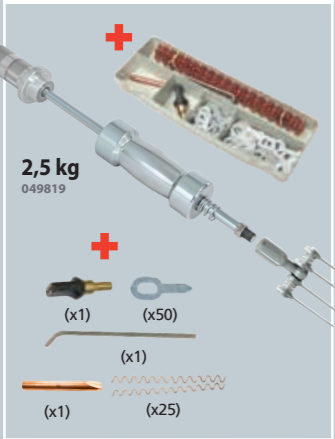

STANDARD

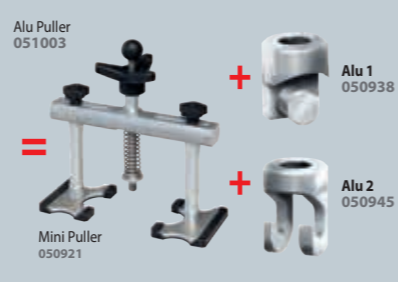
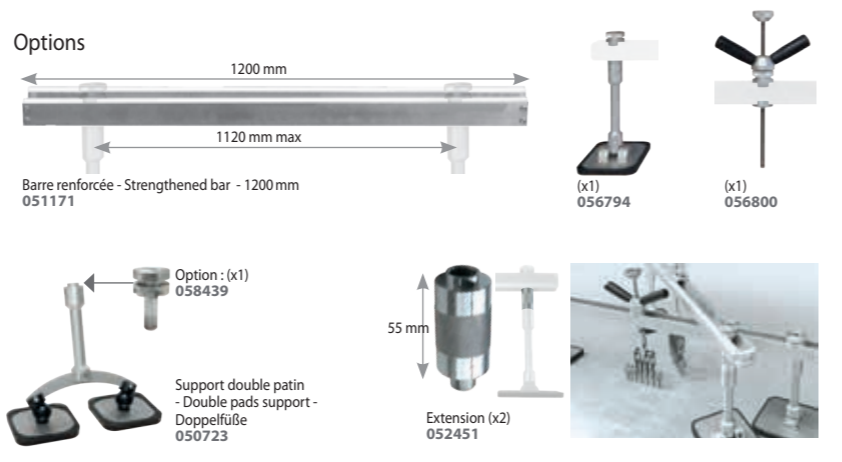
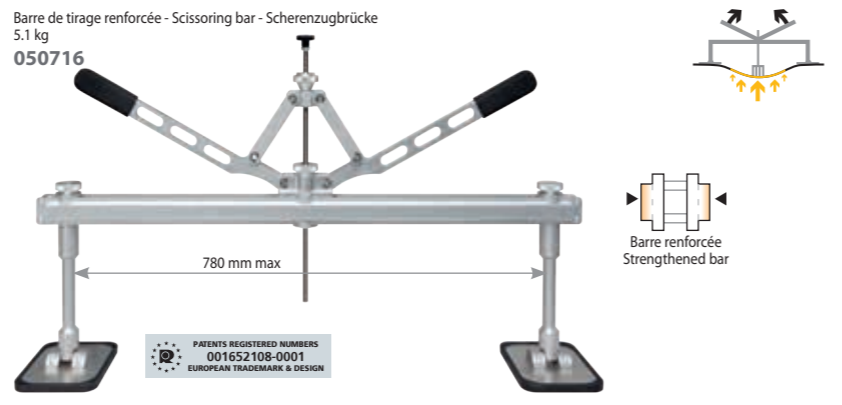
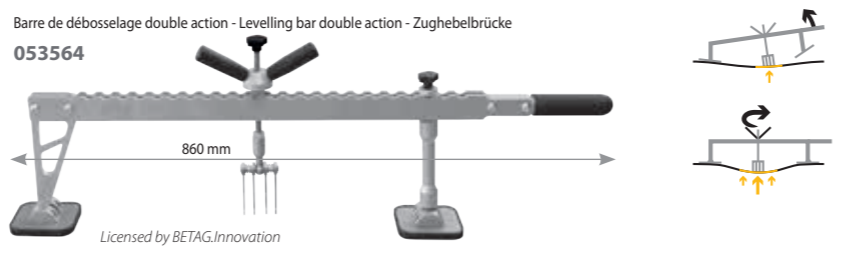
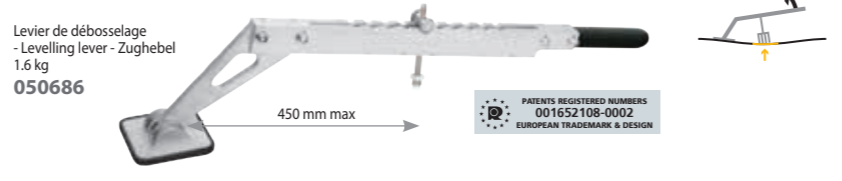

PREMIUM

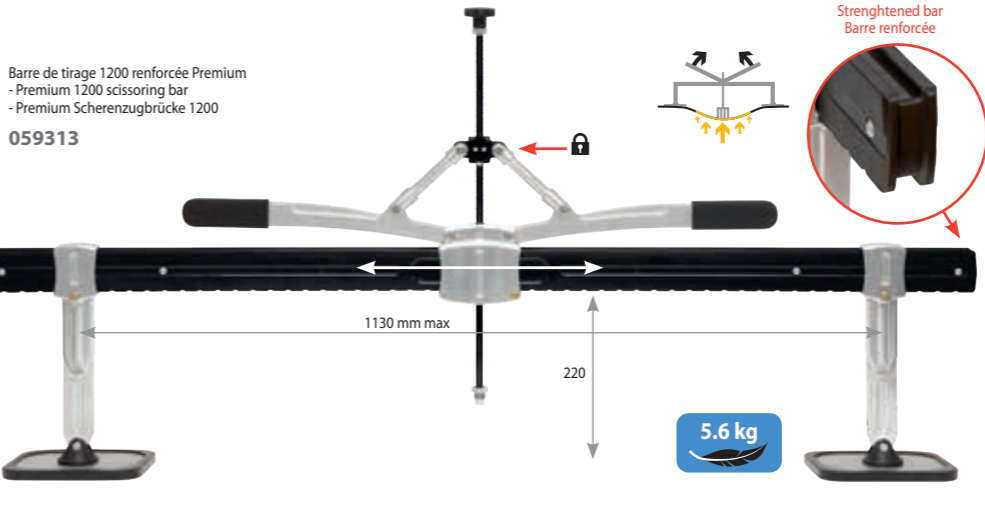
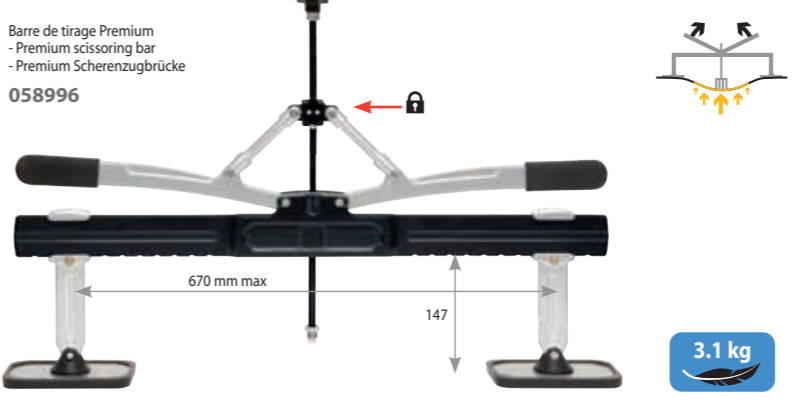
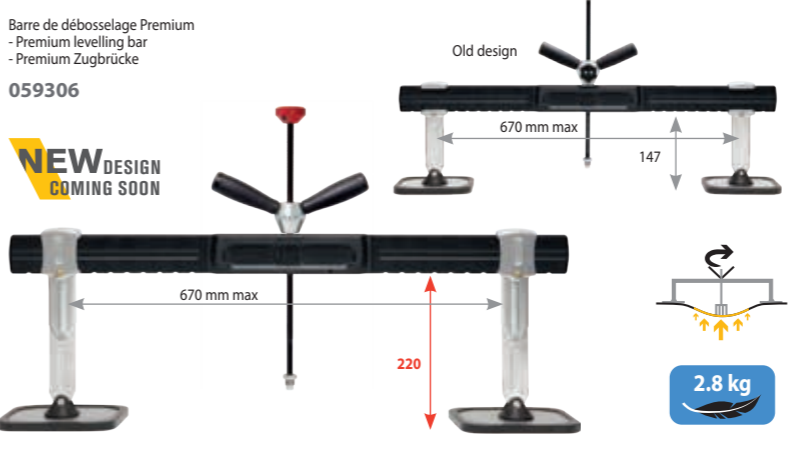
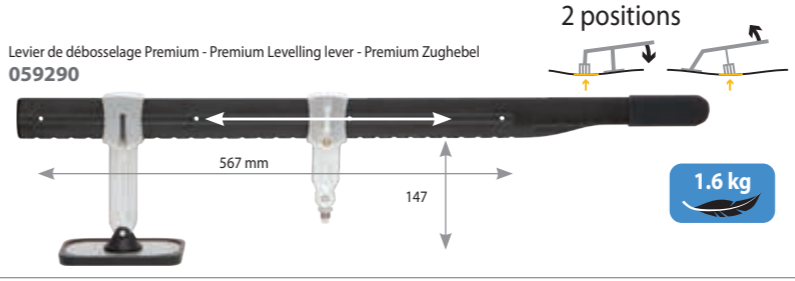

ULTRA LIGHT
ULTRA ERGONOMIC
ULTRA RESISTANT
No deformation
PERFECT BALANCE

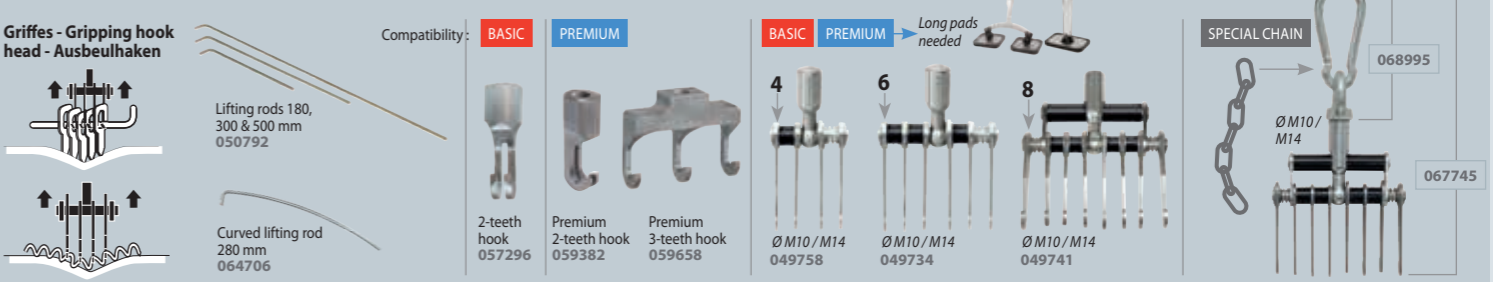
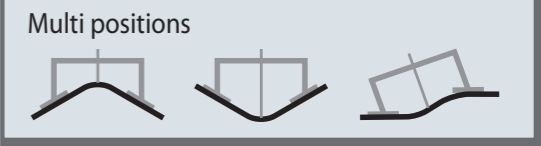



CHARIOTS - Trolleys



Spot 600
39 x 14 x 60 cm, 7.1 kg
053533

Spot 1000
39 x 14 x 60 cm, 10.8 kg
053540

Universal 800
52 x 15 x 80 cm, 18.1 kg
051331



Weld 810
55 x 22 x 78 cm,
21.6 kg
037489

Weld 910 XL
79 x 50 x 115 cm,
27.5 kg
070967

Spot 1600
68 x 20 x 104 cm, 43 kg
051348



Dentstation PRO
81 x 29 x 61 cm, 58 kg
056848

Housse de protection
- Protection cover
- Schutzhaube
for Universal 800
062733
for Spot 1600
048881
for Dentstation Pro
059870

Cable support for
Spot 800, 1600
& Denstation
052284

4 m³ support
for Spot 1600 &
Dentstation Pro
059665

Compatibility

GYSPT	Spot 600	Spot 1000	Weld 810	Weld 910 XL	Universal 800	Spot 1600	Dentstation Pro
2600, 2700	✓	✓	✓	✓	✓	✓	✓
34.02/04	✓	✓	✓	✓	✓	✓	✓
3902/04	✓	✓	✓	✓	✓	✓	✓
PRO 230/400	✓	✓	✓	✓	✓	✓	✓
EXPERT 200/230/400	✓	✓	✓	✓	✓	✓	✓
ALU PRO FV					✓	✓	✓
COMBI 230 E PRO						✓	✓
ARCPULL 200/350			✓	✓			✓
ARCPULL 700				✓			✓



DENT PULLING WORKSTATIONS

UNE SOLUTION COMPLÈTE
A COMPLETE SOLUTION
KOMPLETTLÖSUNGEN

EASYLINER

ALL IN 1 BOX

GYSPT (guns & consumables included) SPOT 1000 053540 Levelling bar double action 053564 + Dent box easy 053632

39.02 053618 GYSPT 39.02 ✓

PROLINER

GYSPT (guns & consumables included) UNIVERSAL 800 051331 Cable support 052284 Levelling bar double action 053564 + Dent box bar 050037

39.02 035775 GYSPT 39.02 ✓

39.04 035782 GYSPT 39.04 ✓

PRO 230 035799 GYSPT PRO 230 ✓

PRO 400 035805 GYSPT PRO 400 ✓

GYSPT (guns & consumables included) UNIVERSAL 800 051331 Cable support 052284 Alu puller 051003

ALU PRO FV 035836 GYSPT ALU PRO FV ✓ ✓ ✓

GYSPT (guns & consumables included) Weld 810 037489 Cable support 052284 Arc puller premium 065161

ARC PULL 200 065260 GYSPT ARC PULL 200 ✓ ✓ ✓



SPEEDLINER

ALU PRO FV 036055	GYSPOT ALU PRO FV													
39.02 035010	GYSPOT 39.02													
39.04 035027	GYSPOT 39.04													
PRO 230 036017	GYSPOT PRO 230													
PRO 400 036024	GYSPOT PRO 400													
EXPERT 200 028180	GYSPOT EXPERT 200													
EXPERT 230 066984	GYSPOT EXPERT 230													
EXPERT 400 028197	GYSPOT EXPERT 400													
COMBI 230EPRO 036062	GYSPOT COMBI 230 E.PRO	✓	x2											
ARC PULL 200 069015	GYSPOT ARC PULL 200 + PRO 230													
+ PRO 400 069053	GYSPOT ARC PULL 200 + PRO 400													
+ EXPERT 200 065284	GYSPOT ARC PULL 200 + EXPERT 200	✓	x2											
+ EXPERT 230 066991	GYSPOT ARC PULL 200 + EXPERT 230													
+ EXPERT 400 065291	GYSPOT ARC PULL 200 + EXPERT 400													✓
without generator 035058														

SPEEDLINER PREMIUM

ARC PULL 200 065277	GYSPOT ARC PULL 200												
PRO 230 068766	GYSPOT PRO 230												
PRO 400 068773	GYSPOT PRO 400												
EXPERT 200 068780	GYSPOT EXPERT 200												
EXPERT 230 068803	GYSPOT EXPERT 230												
EXPERT 400 068827	GYSPOT EXPERT 400												
COMBI 230EPRO 068841	GYSPOT COMBI 230 E.PRO	✓	x2										
ARC PULL 200 069022	GYSPOT ARC PULL 200 + PRO 230												
+ PRO 400 069060	GYSPOT ARC PULL 200 + PRO 400												
+ EXPERT 200 068797	GYSPOT ARC PULL 200 + EXPERT 200	✓	x2										
+ EXPERT 230 068810	GYSPOT ARC PULL 200 + EXPERT 230												
+ EXPERT 400 068834	GYSPOT ARC PULL 200 + EXPERT 400												✓





DENTSTATION

	Dentstation Pro 056848 + Fixing kit 051362	Cable support 052284	Manuspot 050679	Ringmatic 052154	Manual pulling handle 057289	Levelling lever 050686 + Levelling bar 050693 + Scissoring bar 050716	Double pads 050723 + Strengthened bar 051171 + Extensions (x2) 052451	Multihook heads 049758 +049734 +049741	3 lifting rods 050792	Dent box consumables 051515	Empty box 320x 113mm	Magnetic earth 049666	Fast pulling rings (x5) 058712 + Alu puller 051003	Arc puller premium 065161	4 m ³ support 059665 + Flanges (x 2) 062146
39.02 028012	GYSPT 39.02					✓									
39.04 028029	GYSPT 39.04					✓									
PRO 230 036420	GYSPT PRO 230														
PRO 400 036437	GYSPT PRO 400														
EXPERT 200 036734	GYSPT EXPERT 200					✓									
EXPERT 230 067028	GYSPT EXPERT 230														
EXPERT 400 036741	GYSPT EXPERT 400														
COMBI 230 E.PRO 036444	GYSPT COMBI 230 E.PRO	✓	x2			✓							✓		
ARC PULL 200 + PRO 230 069039	GYSPT ARC PULL 200 + PRO 230														
+ PRO 400 069077	GYSPT ARC PULL 200 + PRO 400														
+ EXPERT 200 065321	GYSPT ARC PULL 200 + EXPERT 200	✓	x2			✓								✓	
+ EXPERT 230 067035	GYSPT ARC PULL 200 + EXPERT 230														
+ EXPERT 400 065338	GYSPT ARC PULL 200 + EXPERT 400														

DENTSTATION PREMIUM

	Dentstation Pro 056848 + Fixing kit 051362	Cable support 052284	Manuspot 050679	Ringmatic 052154 + Manual pulling handle 057289	Manual pulling handle 057289 + Premium levelling lever 059290 + Premium levelling bar 059306 + Premium scissoring bar 058996 + Premium levelling lever 1200 059313	Premium double pads support 150 mm 059351 + 220 mm 059375	Hook head 049734 + 059658 + 059382	3 lifting rods 050792	Dent box consumables 051515 + Empty box 320x 113mm	Magnetic earth 049666	Fast pulling rings (x5) 058712 + Alu puller 051003	Arc puller premium 065161	4 m ³ support 059665 + Flanges (x 2) 062146
PRO 230 028067	GYSPT PRO 230												
PRO 400 028074	GYSPT PRO 400												
EXPERT 200 036758	GYSPT EXPERT 200				✓								
EXPERT 230 067042	GYSPT EXPERT 230												
EXPERT 400 036765	GYSPT EXPERT 400												
COMBI 230 E.PRO 036772	GYSPT COMBI 230 E.PRO	✓	x2		✓							✓	
ARC PULL 200 + PRO 230 069046	GYSPT ARC PULL 200 + PRO 230												
+ PRO 400 069084	GYSPT ARC PULL 200 + PRO 400												
+ EXPERT 200 065345	GYSPT ARC PULL 200 + EXPERT 200	✓	x2		✓								✓
+ EXPERT 230 067059	GYSPT ARC PULL 200 + EXPERT 230												
+ EXPERT 400 065352	GYSPT ARC PULL 200 + EXPERT 400												

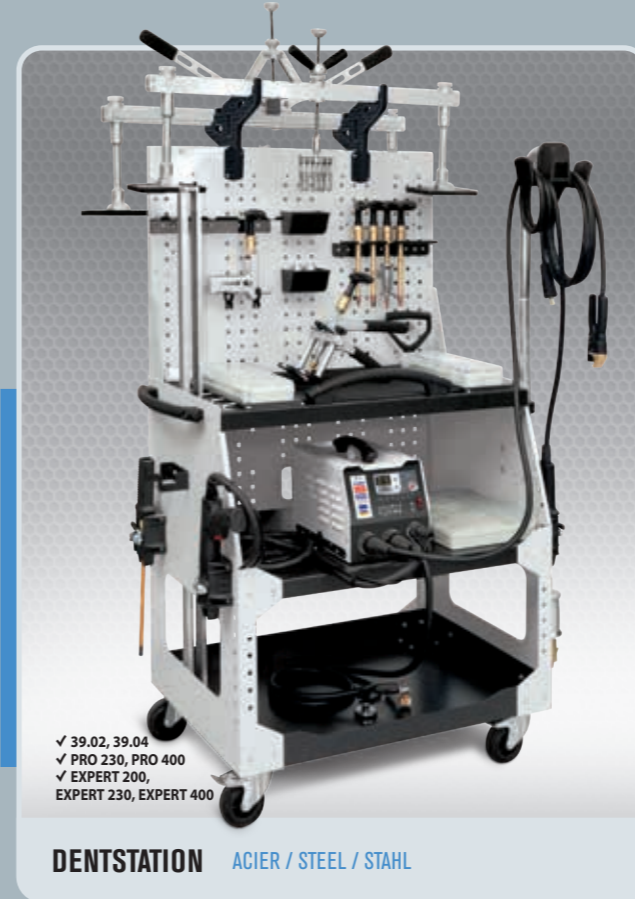

✓ 39.02, 39.04
✓ PRO 230, PRO 400
✓ EXPERT 200, EXPERT 230, EXPERT 400

DENTSTATION ACIER / STEEL / STAHL



COMPLETE SYSTEM

★ ★ ★

✓ COMBI 230 E.PRO
✓ ARC PULL 200 + PRO 230
✓ ARC PULL 200 + PRO 400
✓ EXPERT 200 + ARC PULL 200
✓ EXPERT 230 + ARC PULL 200
✓ EXPERT 400 + ARC PULL 200

DENTSTATION ALU + ACIER / STEEL / STAHL

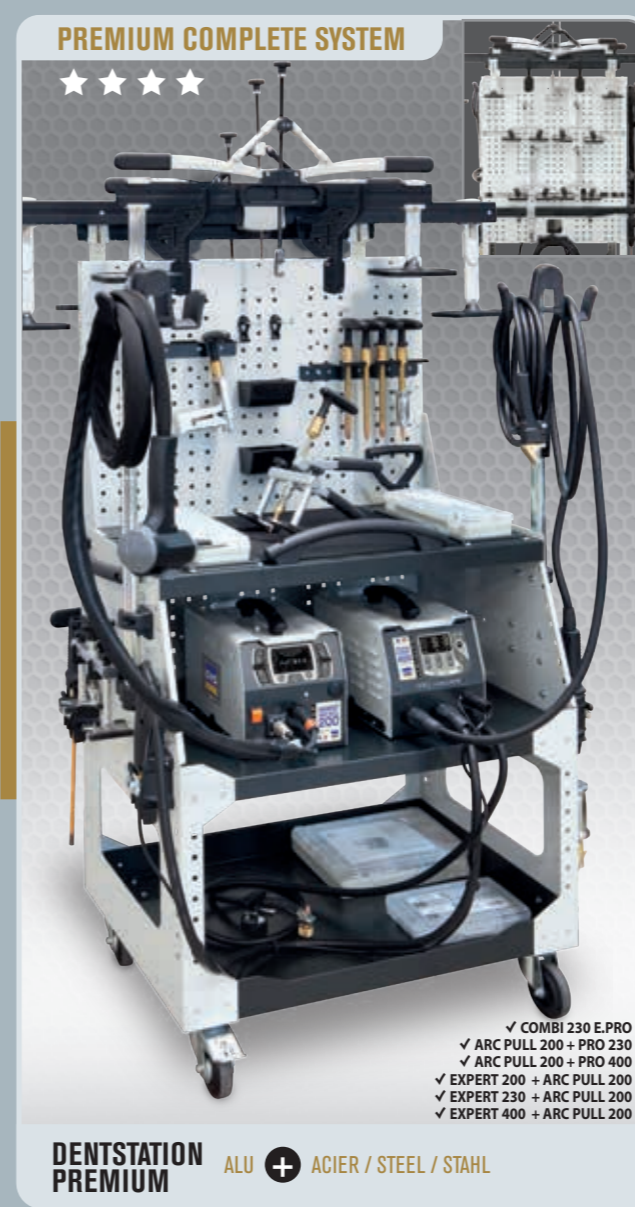

DENTSTATION PREMIUM ALU + ACIER / STEEL / STAHL



DENTSTATION PREMIUM ACIER / STEEL / STAHL

✓ COMBI 230 E.PRO
✓ ARC PULL 200 + PRO 230
✓ ARC PULL 200 + PRO 400
✓ EXPERT 200 + ARC PULL 200
✓ EXPERT 230 + ARC PULL 200
✓ EXPERT 400 + ARC PULL 200

✓ PRO 230, PRO 400
✓ EXPERT 200, Expert 230, EXPERT 400

PULLING SYSTEMS



DRAW ALIGNER

Équerre de tirage - Draw aligner - Schnellausbeul-Richtausleger 052475

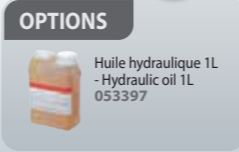
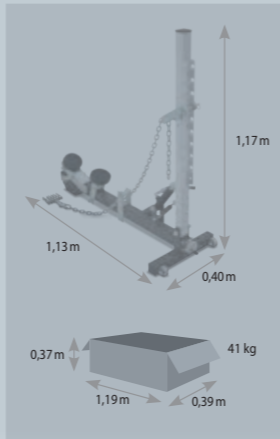
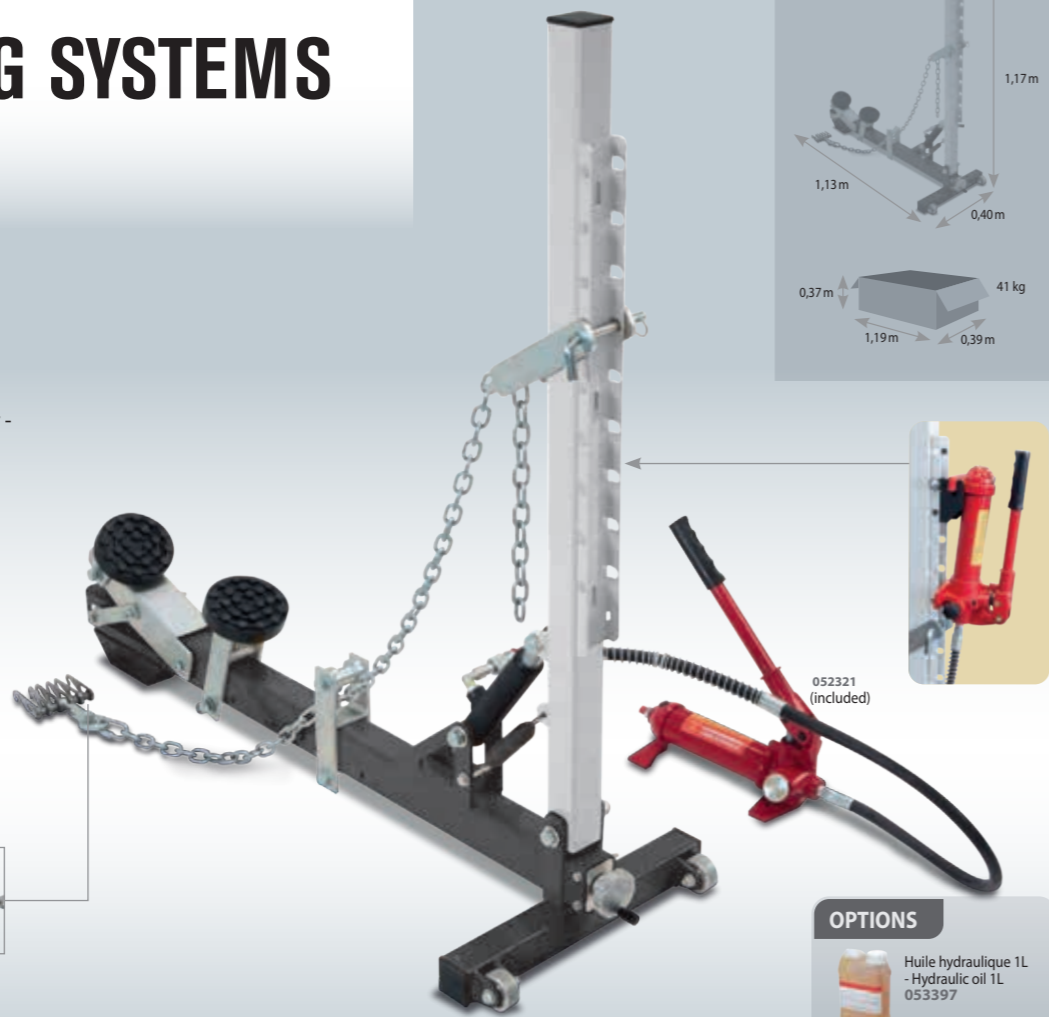
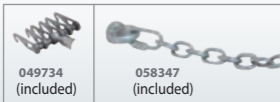
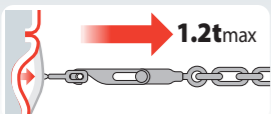

INCLUDED

Câle pour bas de caisse - Wedge for rocker panel

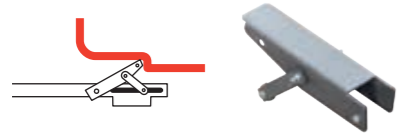

Kit patins pour bas de caisse - Pads kit for rocker panel

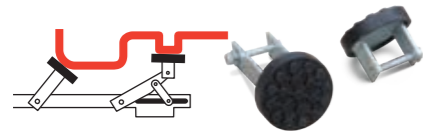

OPTIONS

Bras de bas de caisse - Rocker panel arms for draw aligner - Abstütztraverse für Richtausleger

052581

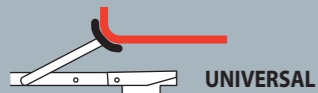

UNIVERSAL



7 kg

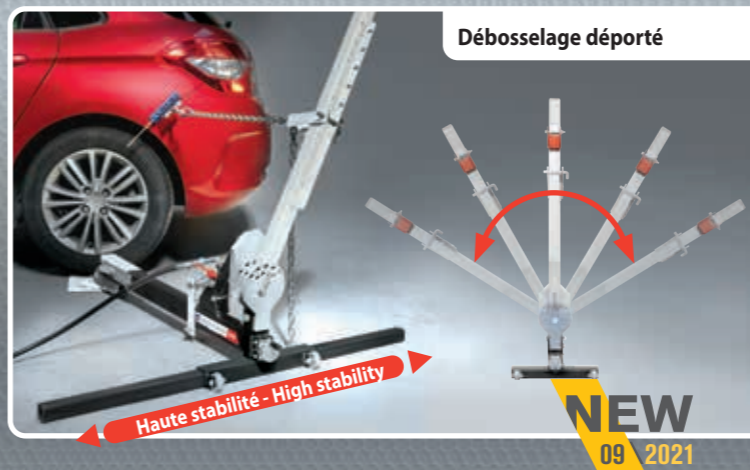

DRAW ALIGNER PRO

069244

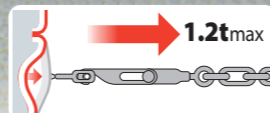

049734 (included)

058347 (included)

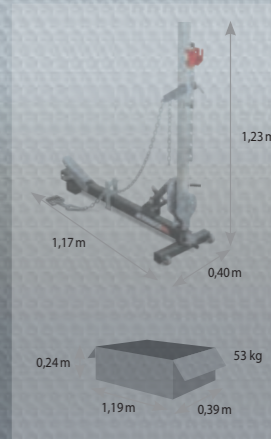
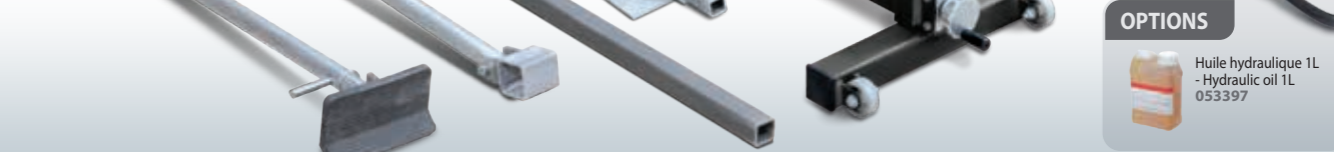

INCLUDED

Câle sous roue - Plate under the wheel

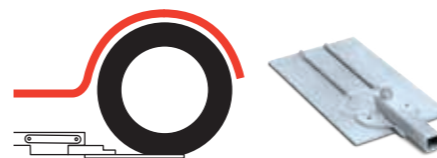

Câle pour bas de caisse - Wedge for rocker panel



Kit bras de bas de caisse et barre de stabilisation - Rocker panel arms and stabilisation bar

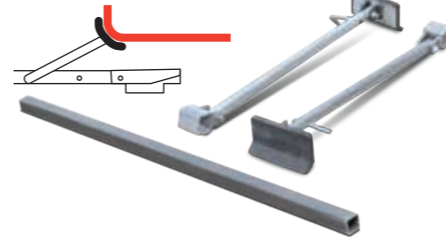

OPTIONS

Kit patins pour bas de caisse - Pads kit for rocker panel

071278



SYSTÈME DE TIRAGE SMART PULLER SILVER

- Smart puller silver pulling system - Schnellausbeul-Richtausleger Smart puller silver

054820

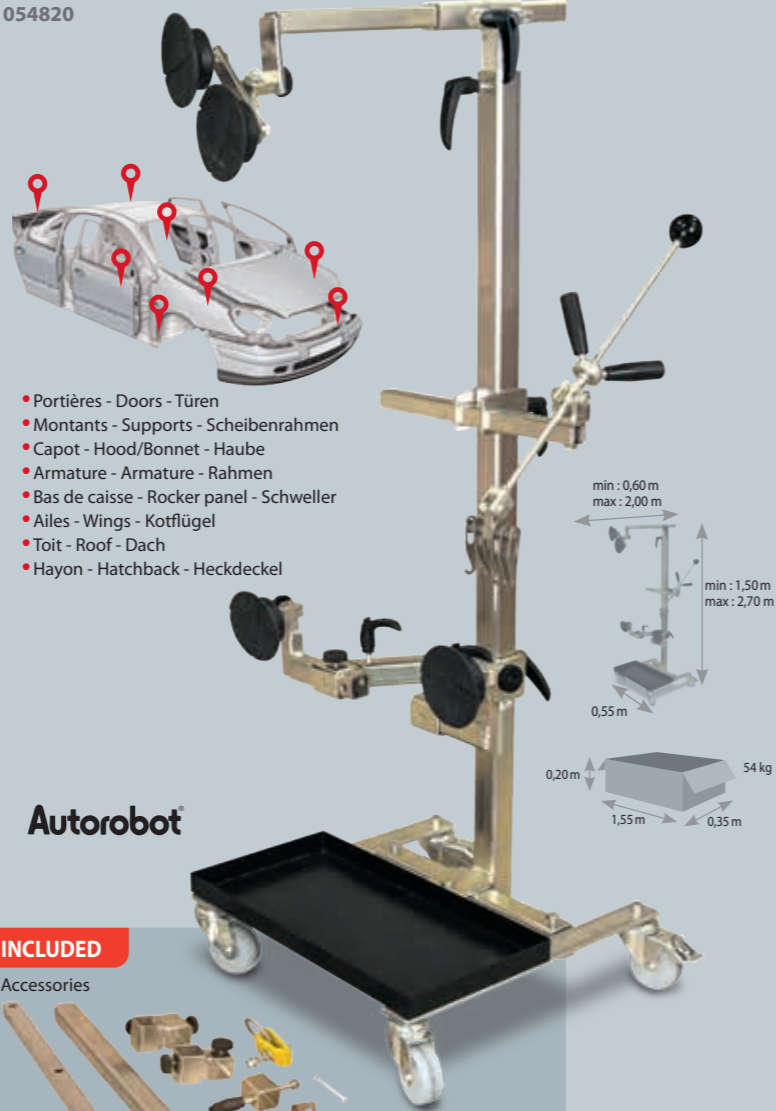
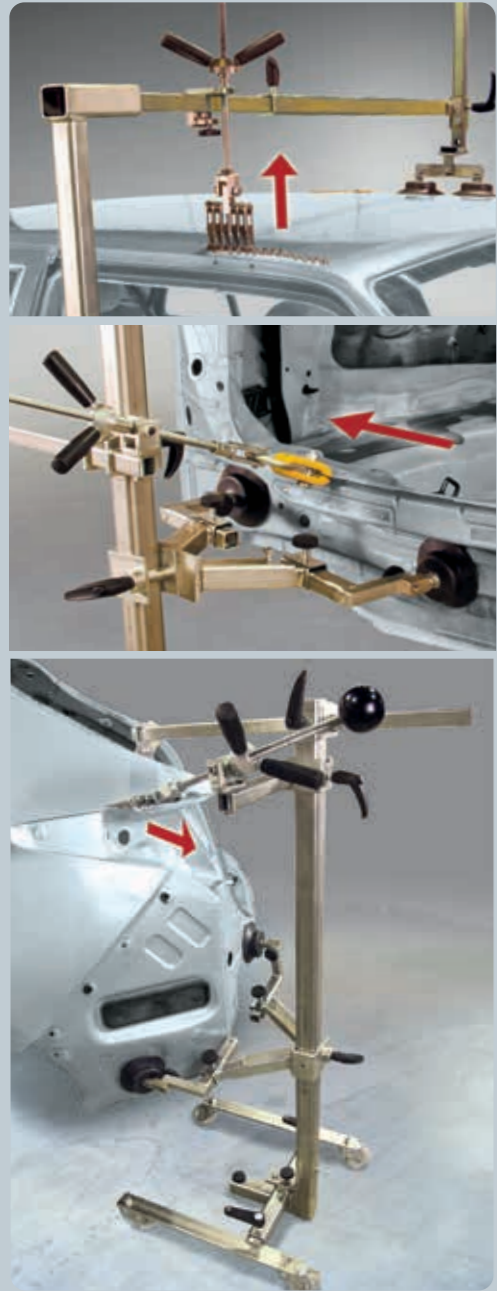

- Portières - Doors - Türen
- Montants - Supports - Scheibenrahmen
- Capot - Hood/Bonnet - Haube
- Armature - Armature - Rahmen
- Bas de caisse - Rocker panel - Schweller
- Ailes - Wings - Kotflügel
- Toit - Roof - Dach
- Hayon - Hatchback - Heckdeckel

Autorobot

INCLUDED

Accessories



Youtube

ELECTRO POWER - Zug-Druckpresse

Non commercialisable en France

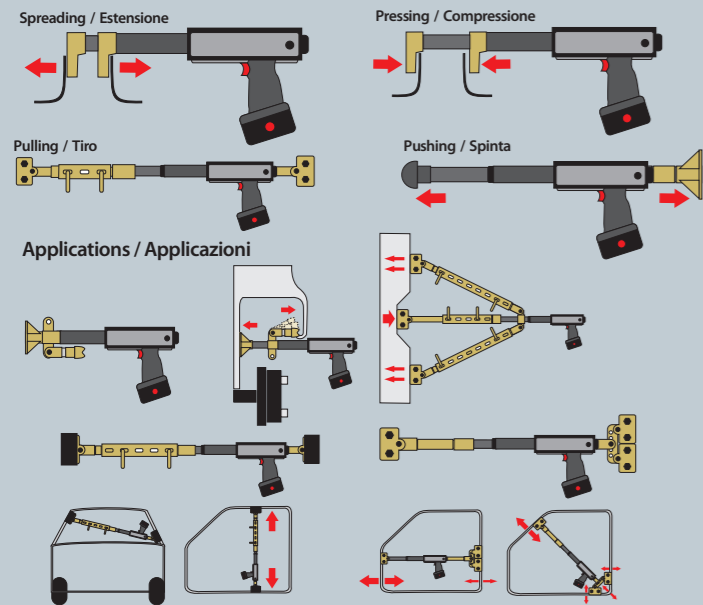

with accessories : 057425

PULLING POWER: 5 Ton.
PUSHING POWER: 5 Ton.
PISTON STROKE: 130 mm



MADE IN ITALY



Standard kit : 425x620x210 mm
Standard kit Total weight: 18 kg
057401

Li-Ion battery (included) 058514



Accessories kit : 425x620x150 mm
Accessories kit Total weight: 20 kg
057418

COFFRET VÉRIN HYDRAULIQUE - Hydraulic cylinder kit - Hydraulischer Drucksatz

MADE IN P.R.C.

BASIC 4T
052345



BASIC 10T
052338

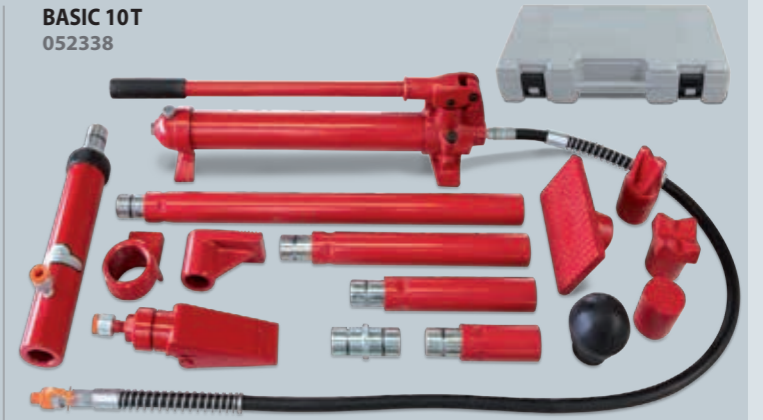

PRO 4T
057432



PRO 10T
057449



OPTIONS

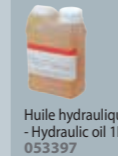

Huile hydraulique 1L
- Hydraulic oil 1L
053397

BARRE D'ANCRAGE - Anchor bar - Türspanner

MADE IN TAIWAN

053045

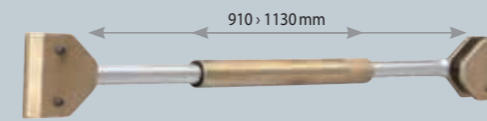

053052



MESURES - Measuring tools - Vermessung

BODYMETER, Mechanical measurements

052130

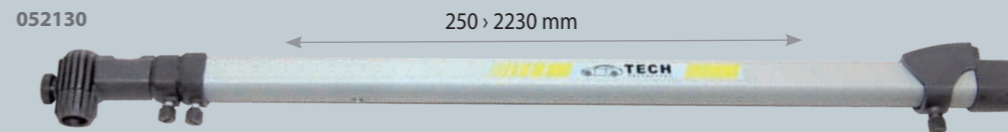

250 > 2230 mm



GYSMETER, Electronic measurements

052093



400 > 2650 mm

Measuring report

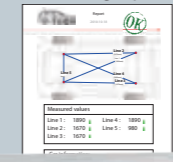

Light weight measuring arm with an easy to read digital display



PINCE PIVOTANTE
- Swivel clamp

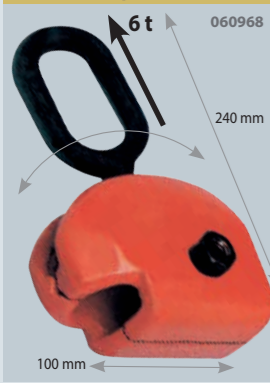

PINCES DE TIRAGE - Frame Straightening - Ziehwerkzeuge

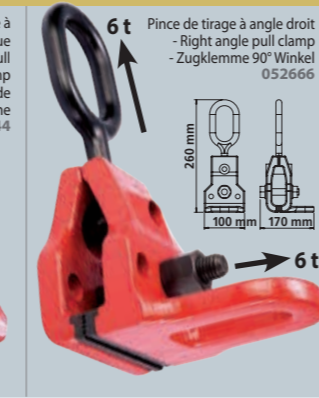
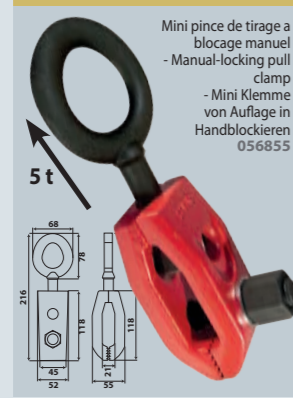

CROCHET DE TIRAGE - Frame Straightening - Ziehwerkzeuge

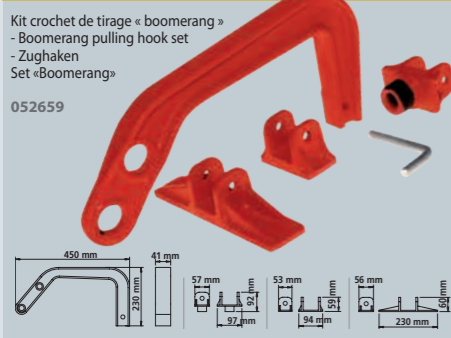

PASSAGE DE ROUE - Arch hooks

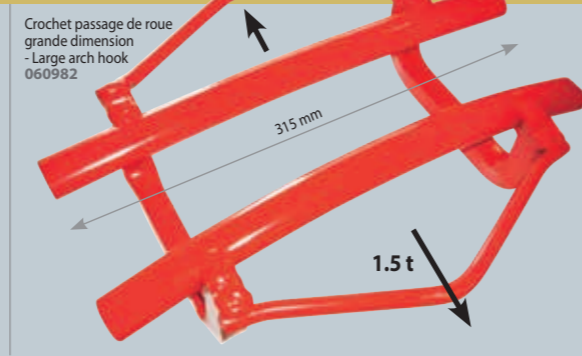
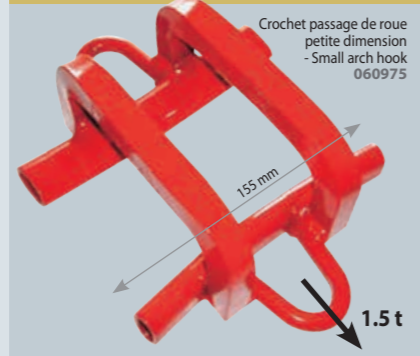

CHAÎNES DE TIRAGE - Frame Straightening - Ziehwerkzeuge

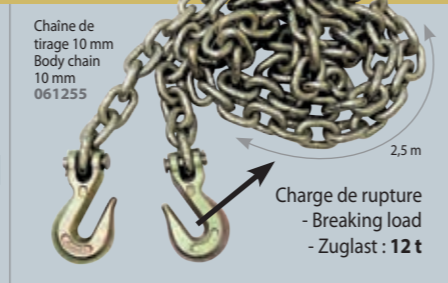
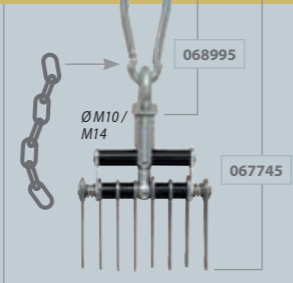
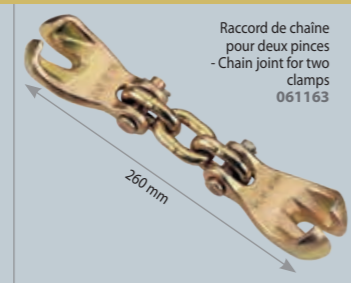
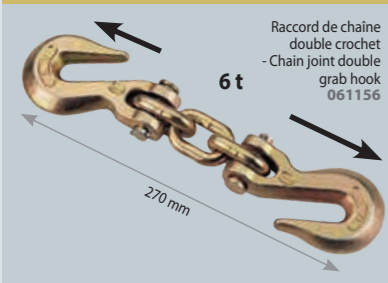

PINCES DE TIRAGE LARGES - Wide pull clamps

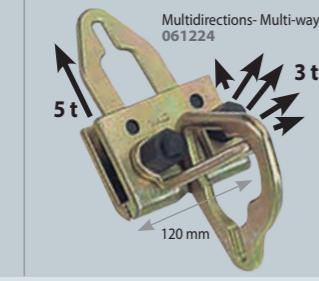
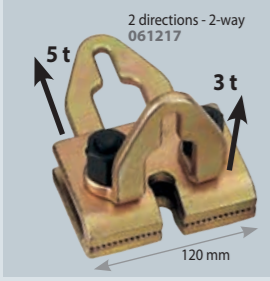

PINCES DE TIRAGE FAIBLE LARGEUR - Small pull clamps

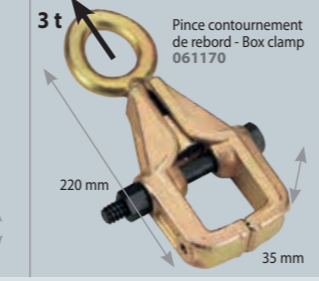
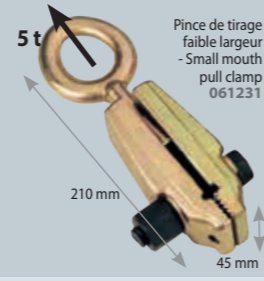
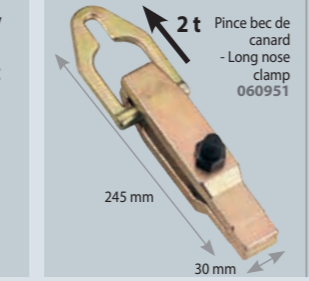

PINCE DE TIRAGE MULTIPLE
- Multiple pull clamp

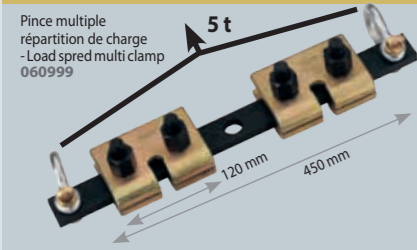

PINCE CISEAUX LARGEUR
45 mm - 45 mm scissors clamp



PINCE DE TIRAGE POUR ANGLE 90°
- 90 Degree corner clamp



PINCE DE TIRAGE TYPE C
- C type clamp

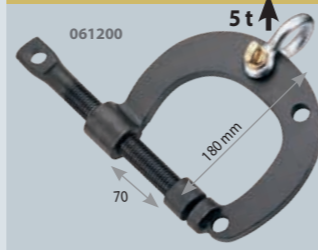

KIT MARTEAU À INERTIE - Inertia hammer kit - Ausziehhammer kit

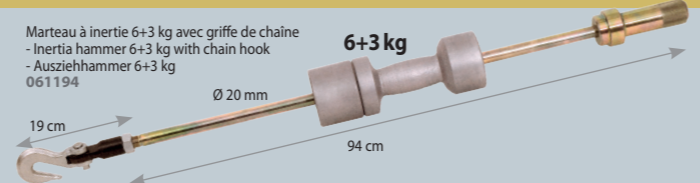

SATELLITE INTELLIGENT - Smart Satellite - Satellit Komplett-Kit

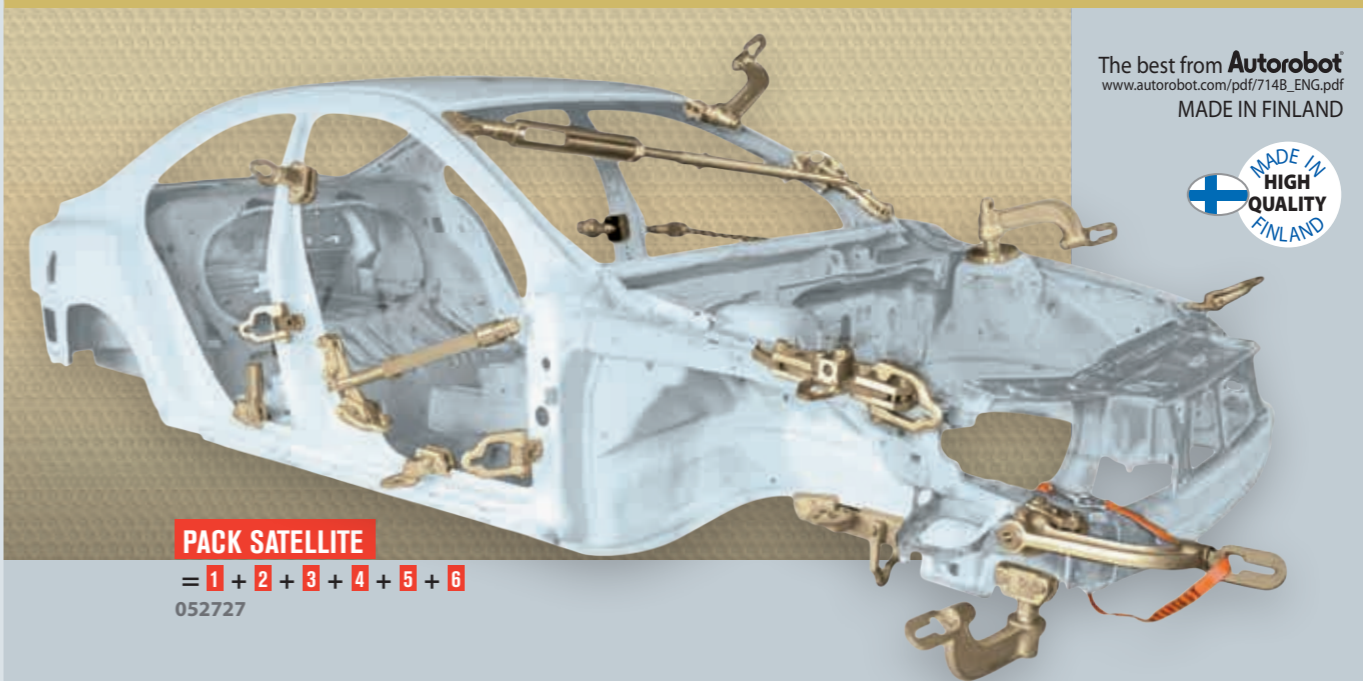

The best from **Autorobot**
www.autorobot.com/pdf/7148_ENG.pdf
MADE IN FINLAND



PACK SATELLITE
= 1 + 2 + 3 + 4 + 5 + 6
052727

1 SATELLITE
- Satellite - Satellit Basisbügel-Set



2 KIT MAC PHERSON (A)
- Mac Pherson Kit - Befestigungs-
Federbein (McPherson)

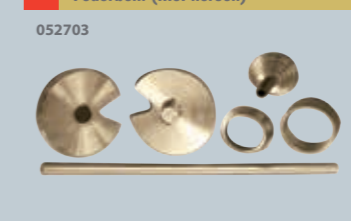

3 BARRE POUR TIRER/POUSSER
- Push/Pull Bar -
Zug/Druck-Stangenset

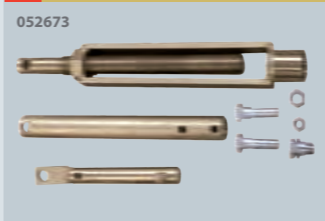

4 SATELLITE (B)
- Bügelverlängerung



5 SANGLE DE SÉCURITÉ
- Safety Strap -
Sicherungsgurt



6 DOUBLE PINCE SATELLITE (C)
- Double Clamp Satellite
- Satellit Doppelklemme



PINCE DE TIRAGE MULTI-USAGE
- Versatile pulling clamp
- Multifunktions-Zugklemme



POWER-PULLER 4T

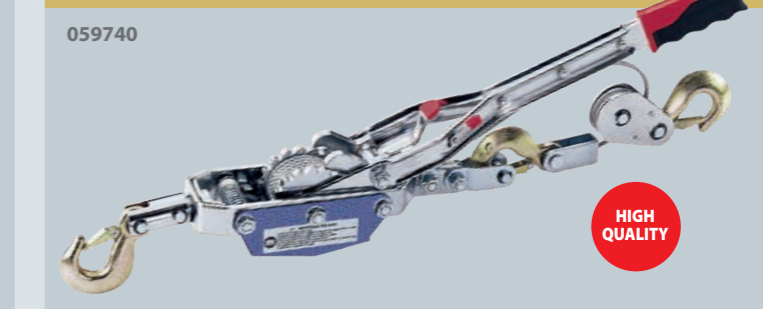



Débosselage rapide et sans peinture
- PDR: Paintless Dent Repair
- Lackschadenfreies Ausbeulen

PAINTLESS DENT REPAIR



Youtube



MADE IN FRANCE

50 Hz	A	W	Freq. kHz	INTEGRATED TECHNOLOGY	Liquid Cooling	Cable (m)	Inductor	cm	kg
230V, 1~	16	2.400	35+120	PFC FV	—	2	2,5	22 x 36 x 27	7,5

OPTION
Spray refroidisseur - Freezer spray
-50°C
400 ml
(x 12)
048898

INDUCTEUR DÉBOSSÉLAGE - Dent Pulling Inductor - Dellenmatrix

GYSDUCTION AUTO DENT REPAIR 054981
= GYSDUCTION AUTO + Dent pulling inductor 054776



Licensed by BETAG.Innovation

INSPECTION CARROSSERIE - Dent Pulling Inductor - Ausbeul Induktor

Planche flexible pour inspection de la carrosserie - Ausbeul-Matrix
Ø 800 mm
059122

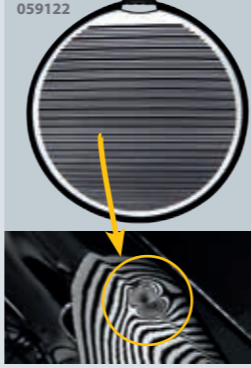

KIT MAGNÉTIQUE DE DÉBOSSÉLAGE SANS PEINTURE - Paintless Dent Repair magnetic kit - Magnetisches Ausbeul-Kit

053168 **EXELTOOLS**

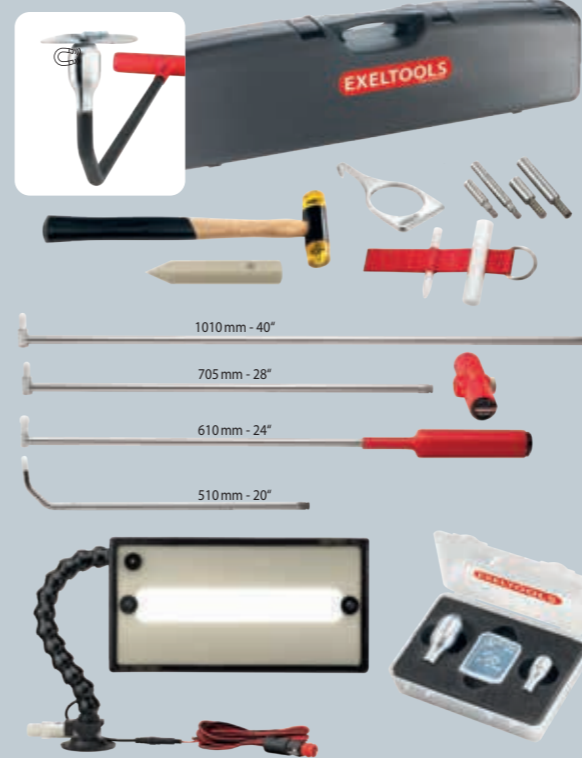

1010 mm - 40"

705 mm - 28"

610 mm - 24"

510 mm - 20"

LAMPES DE DÉBOSSÉLAGE - Paintless Dent Repair lamps - Ausbeullampe

ULTRA LIGHT CARBON X40 PW
053175

EXELTOOLS

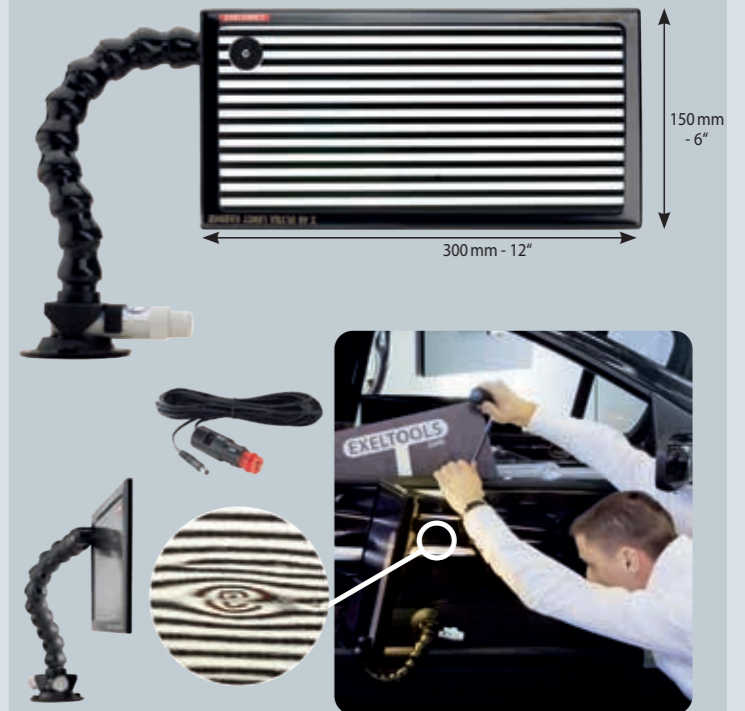

300 mm - 12"

150 mm - 6"

GLUE PULLER PRO (Acier/Alu - Steel/Alu)

Glue Lifter 057364

MADE IN FRANCE

Glue Puller PRO 058699

Glue Puller PRO EXPORT 230V 059160 110V 071056

250 W 230V 052901 110V 071315

050952 (x6) Ø 16, Ø 21, Ø 32

050976 (x10)

061392

050983

BARRETTES ANNEAUX PLASTIQUE - Plastic Multipads Ösen-Klebe pads

(x3) 048089 (x3) 048119 (x3) 048072 (x3) 048102 (x3) 048096

22, 38, 37, 36, 50, 37

156 mm

Colle Glue

OPTIONS

057326 (x3) 048089

057302

050051 380g 213mm

Option 050969

057906 500g 150mm 460mm

acier-steel-Stahl 1.6 kg

057913

Marteau à inertie 500 g - Slide hammer 500 g - Gleithammer 500 g

Jeu de 2 couteaux pour découpe de renforts colles - Set of 2 knives to cut glued reinforcements - 2-er Set Messer zur Klebepadentfernung

KIT DÉBOSSÉLAGE SANS PEINTURE - Dent Pulling Kit (paintless) - Dellenausbeulhebel-Set

33 parts

051959

Paintless Dent Repair Kit

KIT DE 6 COINS DE FRAPPE - Set of 6 pencil punches - Beulenstemmer-Satz mit 6 Tefloneinsätzen

052888

MADE IN FRANCE

MARTEAU INERTIE PNEUMATIQUE - Pneumatic inertia hammer - Unterdruck-Schlaghammer

051904

2,5kg

Ø 60 (x1), Ø 120 (x1), Ø 150 (x1)

KIT COUSSINS GONFLABLES - Air Cushion Kit - Luftpolster-Spreizkissen-Satz

051942

MARTEAU À INERTIE À VENTOUSES (POMPAGE MANUEL) - PUMP AIR SUCTION SLIDE HAMMER - Man. Unterdruck-Schlaghammer

048683

1,1kg

Ø 75 (x1), Ø 100 (x1), Ø 125 (x1)



SPOT LIFT

MOBILE LIFTS

SPOT LIFT EASY

max Air 8 bar **SAFE EN 1494**
max 2.2 t

HEALTH CARE

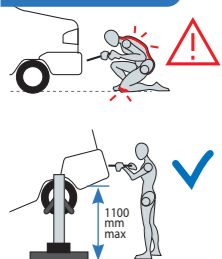

Haute stabilité - High stability

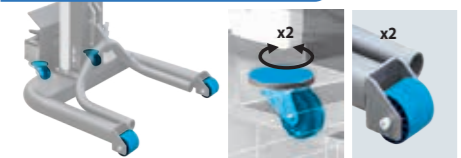

Included 220 bar 053588

NEW

SAFE EN 1494

OPTIONS



Huile hydraulique - Hydraulic oil 11 053397

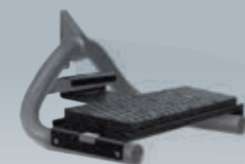

Outil de levage pour bas de caisse - Rocker panel lifting tool - Auflage für Seitenschweller 053236

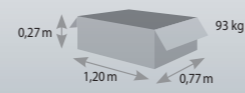

SPOT LIFT PRO

max Air 8 bar **SAFE EN 1494**
max 2.2 t

053557

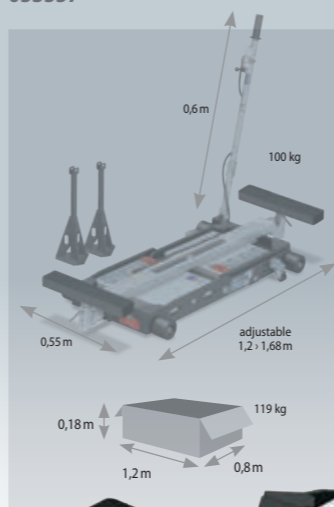

SAFE EN 1494

60 cm (max)
14 cm (min)

SPOT LIFT PRO MOB

max Air 8 bar **SAFE EN 1494**
max 2.2 t

055896

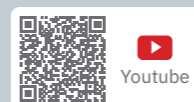

SAFE EN 1494

60 cm (max)
14 cm (min)



OPTIONS

Réhausseur pour 4x4 et utilitaires - Height adjuster for 4x4 & utility vehicles - Erhöhung f. 4x4 und Leicht-LKW



Patins - Pads for Audi & BMW (x 2) 053717

Rampes - Ramps 700 x 200 x 80 mm (x 2) 056787

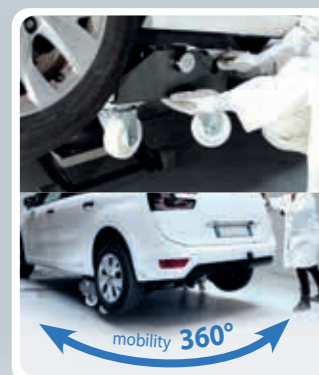

OPTIONS

SPOT LIFT PRO MOB Réhausseur pour 4x4 et utilitaires - Height adjuster for 4x4 & utility vehicles - Erhöhung f. 4x4 und Leicht-LKW



Patins - Pads for Audi & BMW (x 2) 061606

Rampes - Ramps 700 x 200 x 80 mm (x 2) 056787

AUTO ROLL

min 500 mm max 1700 mm (AUTOROLL 1.0m) max 2240 mm (AUTOROLL 1.55m)
2.5 t max

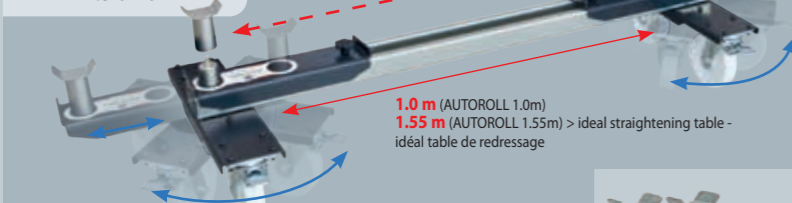

AUTO ROLL 1.0 m / 1.2 t 059047



AUTO ROLL 1.55 m / 1.2 t 063839



AFTER LIFT AUTO ROLL

1 2 **360°**
2.5 t max

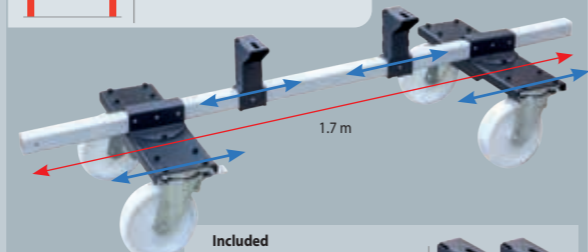

067967 45 Kg

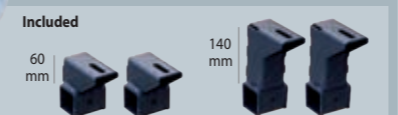

TABOURETS DE MANUTENTION - Wheel trolleys - Radhocker

048768



CHARIOTS DE MANUTENTION PRISE SOUS ROUE - Wheel trucks - Kfz-Montagelift, fahrbar

Chariots mécaniques (x 2) - Mechanic jacks (x 2) 064126

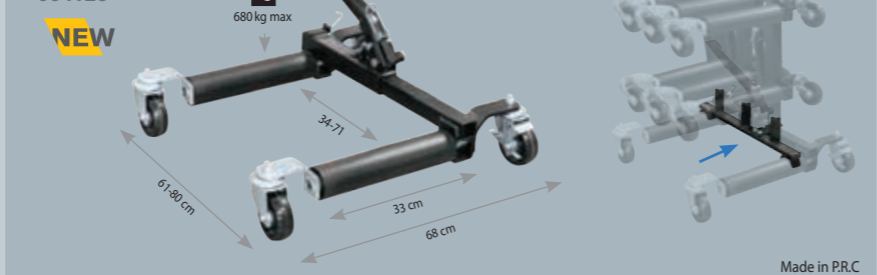

Option Support - Stand 064133

Made in P.R.C



35

SPOT LIFT

MOBILE LIFTS

ERGO LIFT 650

220 V, 1~ **SAFE EN 1493**

max 2 t

056817



Youtube

220 V, 1 ph
0,75 kW

Included
Huile hydraulique -
Hydraulic oil
5l
062160

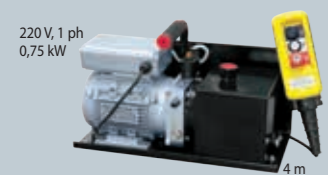

Pack ERGO LIFT 650
+ 4 Wheel trolleys (x4)

068544

NEW



x4

QUICK LIFT L520E

062184

220 V, 1 ph
0,75 kW

Included
Huile hydraulique -
Hydraulic oil
5l
062160

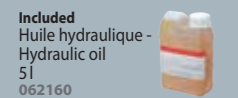
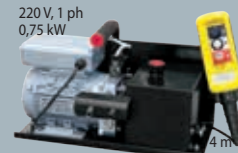

Youtube

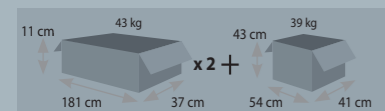

Made in China



OPTIONS

Patins pour SUV -
Pads for SUV
x4
065017



Extensions 1680 mm
x 2
066328



NEW

AIR JACKS

MADE IN
HIGH
QUALITY
ITALY



MANUAL WHEEL LIFT

Lève roue à treuil
- Wheel lift trolley
- Radmontage-Heber
061385

min : R13 / 135 / 65
max : R22 / 300 / 35
40 kg max

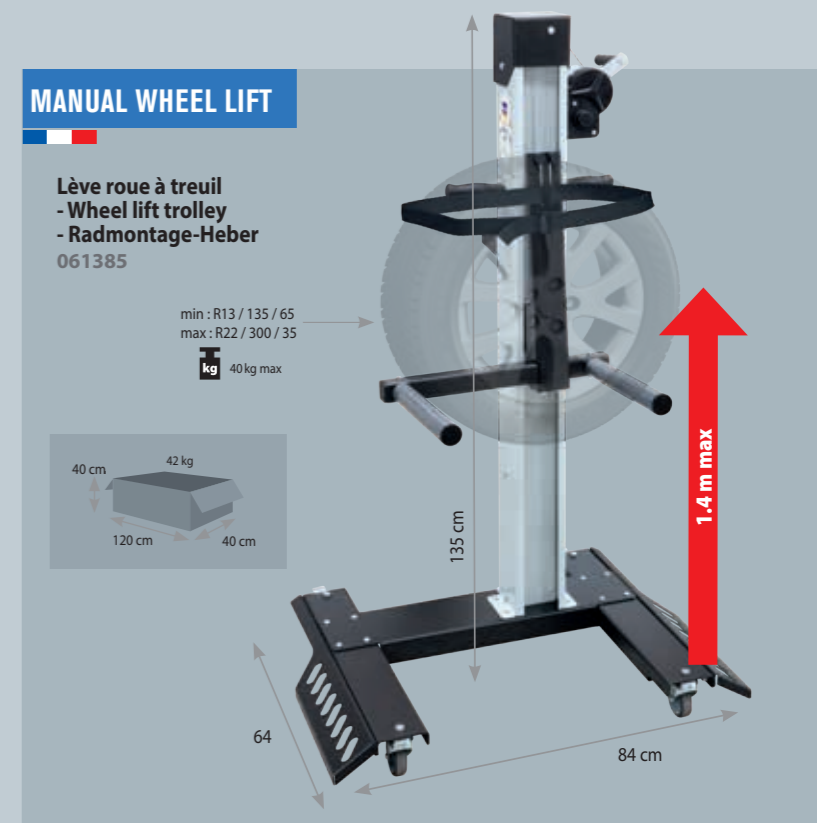
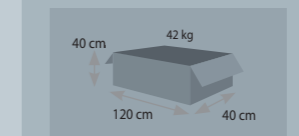

TROLLEY IW1

max 6.5 bar

6.5 bar

063136



Youtube



Liberté de mouvement
- High dexterity

Grande maniabilité et stabilité
- High maneuverability & stability



OPTIONS

Huile hydraulique
- Hydraulic oil
1l
053397

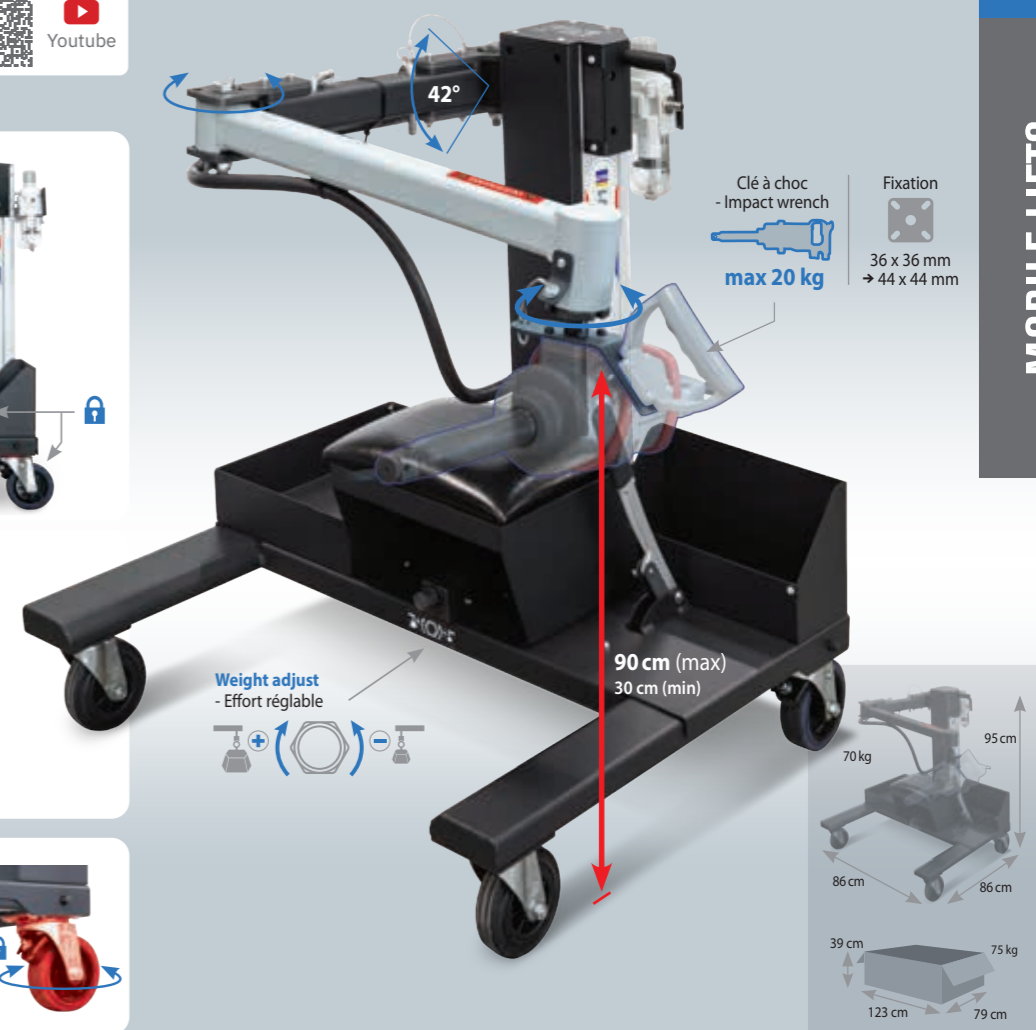

MOBILE LIFTS

37



36

ÉVOLUTION TECHNOLOGIQUE

TECHNICAL IMPROVEMENTS - TECHNISCHE ENTWICKLUNG - MEJORAS TECNICAS

2004
 Facteurs d'évolution :
 • Challenge CO2 = faible poids
 • Crash test = ★★★★★
 • Anti corrosion = nouveaux revêtements
 • Esthétique et visibilité plus sophistiquées.

OLD SOLUTIONS
 Traditional machines
 180 daN max
 6 500 A max
 X clamps
 Ø 4 mm max

2022
 Entwicklungsfaktoren :
 • CO2 Challenge = geringes Gewicht
 • Crash-Test = ★★★★★
 • Anti-Korrosion = neue Beschichtung
 • Modernes Technik-Design.

GYS SOLUTIONS
 INVERTER Technology
 550 daN max
 14 500 A max
 X & C clamps
 Liquid cooled system
 Ø 10 mm

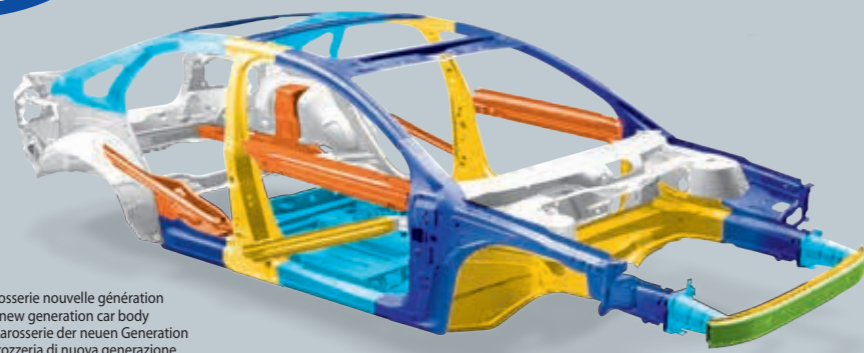
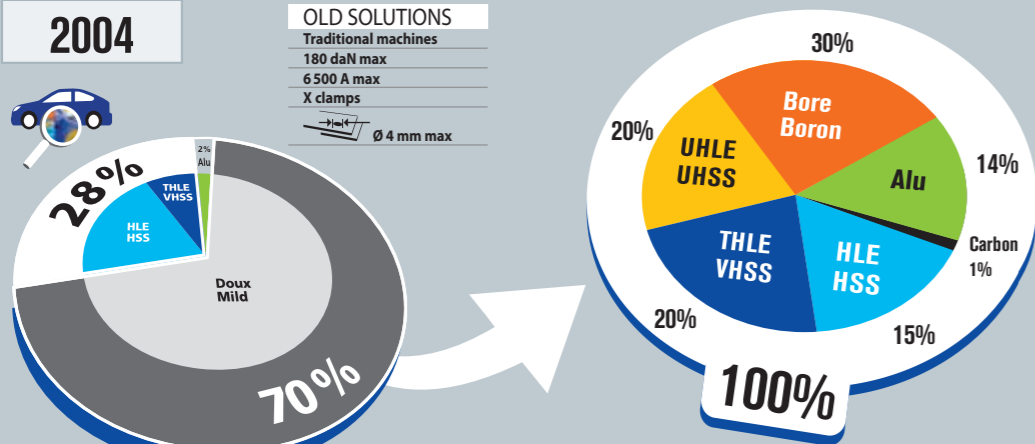

Exemple de carrosserie nouvelle génération
 • An example of new generation car body
 • Beispiel einer Karosserie der neuen Generation
 • Esempio di carrozzeria di nuova generazione

- Mild - Doux
- HSS - HLE
- VHSS - THLE
- UHSS - UHLE
- Bore - Boron
- Aluminium

RANGE

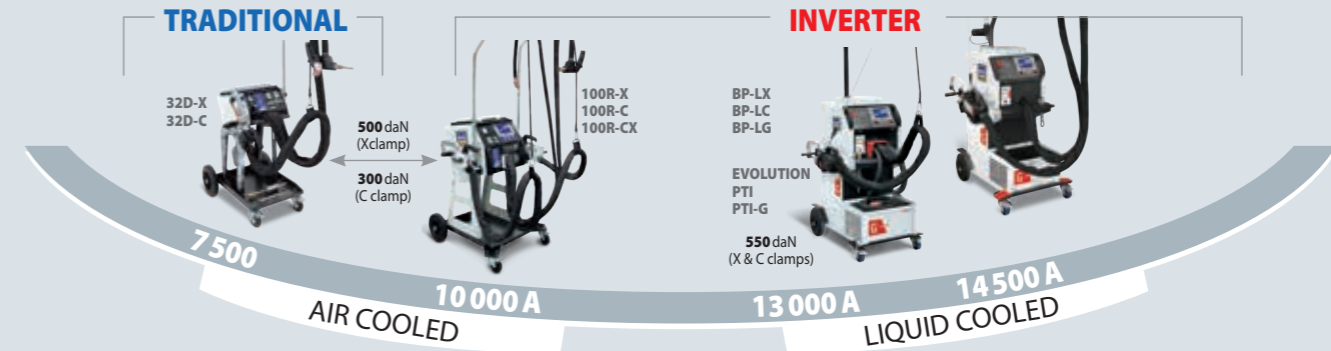

	32 D	100 R	BP / BP-LG	PTI	PTI-G
Doux - Mild	•	•	•	•	•
HLE/THLE - HSS/VHSS	Difficult	•	•	•	•
UHLE/BORE - UHSS/BORON	Difficult	Difficult	•	•	•
Nombre de points - Number of spots 10 spots/min	0,8 + 0,8 mm 5	100 10	no limit 95	60	no limit > 200
Inverter Technology	—	•	•	•	•
EMF Directive 2013/35/UE	—	—	BODY PROTECT TECHNOLOGY	•	•
Système de refroidissement - Cooling system	AIR	AIR	LIQUID	LIQUID	LIQUID
Régulation automatique - Automated regulation	I (A) daN irregular	— • constant	• • constant	• • constant	• • constant
MODE AUTO	—	—	• (LC, LG)	•	•
Pince - Clamp	X C X+C	• (32DX) • (32DC)	• (100R-X) • (100R-C) • (100R-CX)	• (BP.LX) • (BP.LC, BP.LG)	— • —
Transformer Inside Clamp	—	—	—	•	•
Cables (L)	2,5 m	2,5 m	2,5 m	4 or 6 m	6 m
Includes gun	•	•	•	option	option
Cadence de soudage maximale (points/min) - Max welding frequency (spots/min)	0,8 + 0,8 mm 2,5 + 2,5 mm	10 6	10 10	BP-LC : 10 - BP-LG : 20 2 6 10	10 10
Fuse	400 V 200/208-240 V	32 A	40 A	32 A 40 A 50 A	32 A 40 A 50 A 20 A 25 A

HOMOLOGATIONS PRODUITS

MANUFACTURER APPROVALS / COMPLIANCE - PRODUKT HOMOLOGATIONEN - PRODOTTI APPROVATI



Machine	Volkswagen Group	Jeep	Mercedes	smart	EvoBus	Renault	Nissan	GM	Tata	Becher	Kia	Land Rover	Ford USA	Honda USA	NIO
DENT PULLER															
GYSPT 2600/2700	•	•	•	•	•	•	•	•	•	•	•	•	•	•	•
GYSPT 39.02/04, PRO230/400 EXPERT 200/400	•	•	•	•	•	•	•	•	•	•	•	•	•	•	•
PROLINER/SPEEDLINER/DENTSTATION	•	•	•	•	•	•	•	•	•	•	•	•	•	•	•
GYSPT ALU FV	•	•	•	•	•	•	•	•	•	•	•	•	•	•	•
ARCPULL 200	•	•	•	•	•	•	•	•	•	•	•	•	•	•	•
RESISTANCE SPOTWELDERS															
GYSPT 32D	•	•	•	•	•	•	•	•	•	•	•	•	•	•	•
GYSPT INVERTER 100R	•	•	•	•	•	•	•	•	•	•	•	•	•	•	•
GYSPT INVERTER BP-LX	•	•	•	•	•	•	•	•	•	•	•	•	•	•	•
GYSPT INVERTER BP-LC-s7	•	•	•	•	•	•	•	•	•	•	•	•	•	•	•
GYSPT INVERTER BP-LCX-s7	•	•	•	•	•	•	•	•	•	•	•	•	•	•	•
GYSPT INVERTER BP-LG	•	•	•	•	•	•	•	•	•	•	•	•	•	•	•
GYSPT EVOLUTION PTI-s7	•	•	•	•	•	•	•	•	•	•	•	•	•	•	•
GYSPT INVERTER PTI-G	•	•	•	•	•	•	•	•	•	•	•	•	•	•	•
VAS 821 101 - Spot Welder	•	•	•	•	•	•	•	•	•	•	•	•	•	•	•
RIVE TING															
GYSPRESS 10T	•	•	•	•	•	•	•	•	•	•	•	•	•	•	•
MIG / MAG															
T1 GYS AUTO	•	•	•	•	•	•	•	•	•	•	•	•	•	•	•
T3 GYS AUTO	•	•	•	•	•	•	•	•	•	•	•	•	•	•	•
AUTOPULSE 220-M3	•	•	•	•	•	•	•	•	•	•	•	•	•	•	•
AUTOPULSE 320-T1	•	•	•	•	•	•	•	•	•	•	•	•	•	•	•
AUTOPULSE 320-T3	•	•	•	•	•	•	•	•	•	•	•	•	•	•	•
VAS 821 005 - Pulse MIG Welder	•	•	•	•	•	•	•	•	•	•	•	•	•	•	•
VAS 821 00580 023	•	•	•	•	•	•	•	•	•	•	•	•	•	•	•
PLASMA															
EASYCUT 40	•	•	•	•	•	•	•	•	•	•	•	•	•	•	•
CUTTER 25K/35KF	•	•	•	•	•	•	•	•	•	•	•	•	•	•	•
CUTTER 30FV/45CT	•	•	•	•	•	•	•	•	•	•	•	•	•	•	•



BP BODYPROTECT TECHNOLOGY 2013/35/UE
 UNIQUE ELECTRO-MAGNETIC FIELD PROTECTION by GYS

LA SOLUTION GLOBALE - THE GLOBAL SOLUTION

®BODY PROTECT is a proprietary GYS technology that minimises electromagnetic fields created by the machine.
 Compliant : Directive 2013/35/UE
 Certified by : Laboratory EMITECH
 MADE IN FRANCE

Other technologies	GYS BODYPROTECT TECHNOLOGY
B1: 10 < 25 cm (Norm : 3 cm max)	B1: 0 cm (Norm : 3 cm max)
B2: 25 < 35 cm (Norm : 30 cm max)	B2: 5 cm (Norm : 30 cm max) / 4 cm (Norm : 30 cm max)
B3: 35 cm (Norm : 20 cm max)	B3: 0 cm (Norm : 20 cm max)
B4: 35 cm (Norm : 20 cm max)	B4: 0 cm (Norm : 20 cm max)

SPOT WELDING

PORTASPOT 230
6 300 A 120 daN
 Air cooled

230V
022256

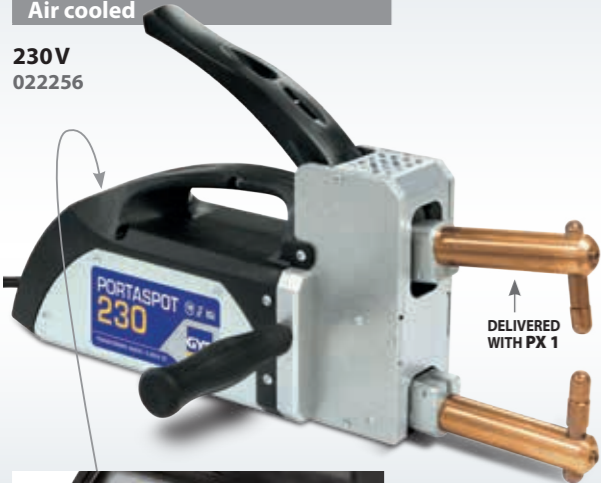

DELIVERED WITH PX 1

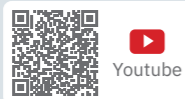

ARMS Ø 23 mm

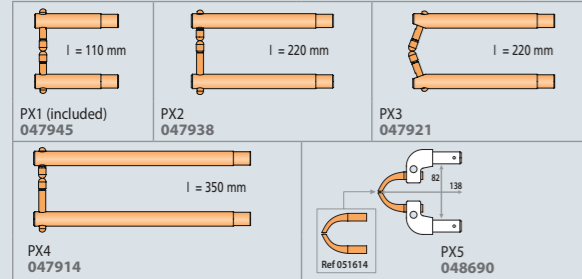

ELECTRODES

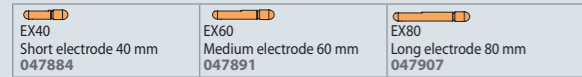

CAPS & ACCESSORIES



50/60 Hz	A	A	A	mm	V	m	mm ²	100% CU	(no arm) cm	kg
1 x 230V	16(D)	6 300	8 900	2+2	2,45	2,5	3x2,5 H05VVf	OK	36x29 x10	10

GYSPOT 32D-X
7 500 A 500 daN
 Air cooled
 2 x 400V
 019881



GYSPOT 32D-C
7 500 A 300 daN
 Air cooled
 2 x 400V
 019898



GYSPOT INVERTER 100R-X
10 000 A 500 daN
 For mild steel, HSS, UHSS
 Air cooled
 Traceability software
 Save spot welding configuration and export data
 3 x 400V
 019911



GYSPOT INVERTER 100R-C
10 000 A 300 daN
 For mild steel, HSS, UHSS
 Air cooled
 Traceability software
 Save spot welding configuration and export data
 3 x 400V
 019928



GYSPOT INVERTER 100R-CX
10 000 A 500 daN (X) 300 daN (C)
 For mild steel, HSS, UHSS
 Air cooled
 Traceability software
 Save spot welding configuration and export data
 3 x 400V
 022317



OPTIONS



INCLUDED

	019881	019898	019911	019928	022317
32D-X	■	■	■	■	■
32D-C	■	■	■	■	■
100R-X	■	■	■	■	■
100R-C	■	■	■	■	■
100R-CX	■	■	■	■	■

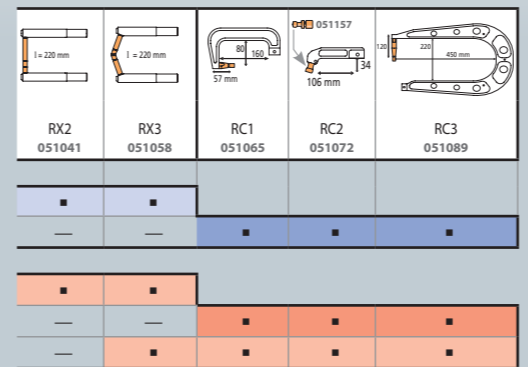

MADE IN FRANCE	50/60 Hz	A	A	A	mm	U _o	Cables		100% CU	kg			
							Air Cooled	mm ²					
GYSPOT 32D.X GYSPOT 32D.C	2 x 400V	32 (13 kVA) 40 (16 kVA)	6 10	7 500	10 500	3 + 3	1,2 + 3	11	2,2	200	OK	55 x 75 x 190	78
									2,5	150			
GYSPOT 100R.X GYSPOT 100R.C GYSPOT 100R.CX	3 x 400V	32 (22 kVA) 40 (28 kVA) 50 (35 kVA)	2 6 10	10 000	—	2,5+2,5+2,5	1,5 + 3	16	2,5	200	OK	70 x 99 x 208	107
									2,5	150			
									—	8			

GYSPT INVERTER
BP-LX
13 000 A
550 daN

For mild steel, HSS, UHSS **Boron steel**

Double pressure
Ø 10 mm
6,5 kg (included X1)

Liquid cooled

BP BODYPROTECT
Unique electro-magnetic field protection
2013/35/UE by GYS

Traceability software
Save spot welding configuration and export data

019652

	019652	058804
400V		
Gyspot BP-LX	■	■
Monopoint/Spot 049291	■	■
Spotter box pro (p.10) 050075	■	■
Inertia hammer 049482 + 049802	■	■
X1 050501	■	■
X4A (x2) + X4B + X4C + X2 020733	■	■
Liquid cooling (10l) 052246		(x3)

Included Support haute stabilité
-High stability support
Compatible gyro +



OPTIONS

050068
x10 (x20: 052239) x18 (x6: 049987)
x6 (x6: 049994) x18 (x6: 049970)

048935 x40 (x6: 049987)

SD CARD 050914

Liquide de refroidissement
Cooling liquid
Kühlmittel
Enfriamento líquido
Refrigeración líquida

052246

Housse de protection
- Protection cover
- Schutzhaube
for BP & PTI

050853

GYSPT INVERTER
BP-LC-s7
13 000 A
550 daN

For mild steel, HSS, UHSS **Boron steel**

Double pressure
Ø 10 mm
6,5 kg (included C1)

Liquid cooled

BP BODYPROTECT
Unique electro-magnetic field protection by GYS

EDC Automatic C clamp
Energy Dynamic Control

Traceability software
Save spot welding configuration and export data

020757

	020757	058798
400V		
Gyspot BP-LC-s7	■	■
Monopoint/Spot 049291	■	■
Spotter box pro (p.10) 050075	■	■
Inertia hammer 049482 + 049802	■	■
Contact grease 050440	■	■
Caps remover 050846	■	■
Arm panel	■	■
C1 019140	■	■
C2 + C3 + C4 019126	■	■
C6 019775	■	■
Liquid cooling (10l) 052246		(x3)

OPTIONS BP-LC

GYRO 360° for BP-LC 051737

10-14 kg

GYSPT INVERTER
EVOLUTION PTI
14 500 A
550 daN

For mild steel, HSS, UHSS **Boron steel**

FUSE 16>25 A
Double pressure
Ø 10 mm
9,9 kg (included C1)

TRANSFORMER INSIDE

Liquid cooled

EDC Automatic C clamp
Energy Dynamic Control

Traceability software
Save spot welding configuration and export data

020894

	4M 022188	4M 020894	4M 067998
	6M 022195	6M 020900	
220V		400V	
Gyspot Evolution PTI	■	■	■
Contact grease 050440	■	■	■
Caps remover 050846	■	■	■
Arm panel	■	■	■
C1 021402	■	■	■
C2 + C3 + C4 021457	■	■	■
C6 019775	■	■	■
Gyro 360° 051720	■	■	■
Complete gun kit 067318	■	■	■
Liquid cooling (10l) 052246			(x3)

MADE IN FRANCE 62135	50/60 Hz	A D curve	Spots/min (max) ± 2.5+2.5	RMS A	Uo V	mm			Cables			100% CU	cm	kg
						↕	↔	↔	↔	↔	↔			
GYSPT BPLX	3 x 400V	32 (22 kVA) 40 (28 kVA) 50 (35 kVA)	2 6 10	13 000	16	2.5+2.5+2.5	1.5+3	2.5, liquid	2.5	8 m, 4x6 H07RN-F	OK	65 x 80 x 205	150	
GYSPT BP-LC-s7														
GYSPT EVOLUTION PTI-s7	3 x 400V	16 (11 kVA) 20 (14 kVA) 25 (17 kVA)	10	11 500 14 500	7.3	2.5+2.5+2.5	1.5+3	4 m, liquid	OPTION 067318: 1.6 m, Ø 200 mm ²	OK	65 x 80 x 230	98.5		
GYSPT EVOLUTION PTI-s7 220 V														
	3 x	200 208 220 240		30 (10-12 kVA) 40 (14-16 kVA) 50 (17-21 kVA)				4 m, liquid						

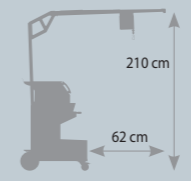

Very light
9,9 kg



OPTION

supports

NEW
200 mm² 1.6 m
300 mm² 1m

Complete gun kit 067318

GYRO 360° for PTI 051720

FOR GYSPOT 32D-X, 100R-X, BP-LX, BP-LCX

550 daN

6,5 kg including X1

- DOUBLE PRESSURE
- LIQUID COOLED / REFRIGERATION LIQUIDE
- Ø 10 mm



X ARMS
Ø 25 mm

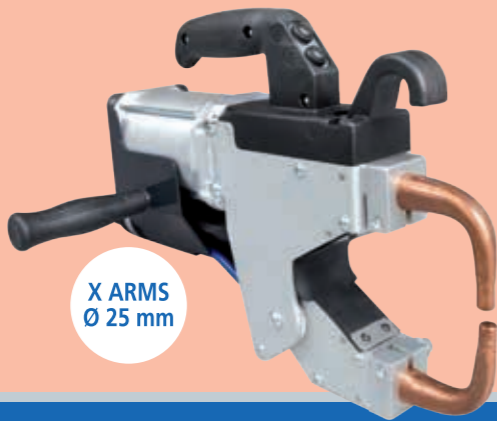

X Arms - Caps Ø13 mm

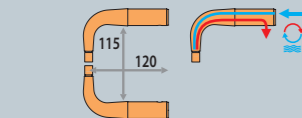

X1 8 bar/550 daN
050501

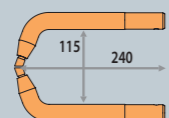

X2 8 bar/400 daN
050518

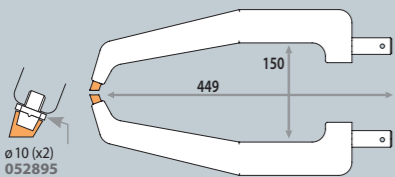

X4 8 bar/120 daN
050532

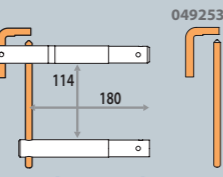

X5 8 bar/200 daN
050549



X4A 8 bar/150 daN
020702

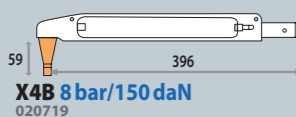

X4B 8 bar/150 daN
020719

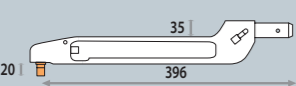

X4C 8 bar/150 daN
020726

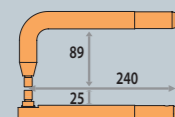

X6 8 bar/400 daN
050587

X4 (A, B & C) combinations

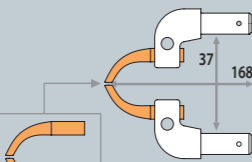
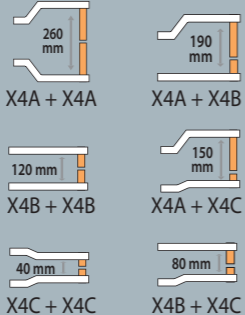

X11 3 bar/150 daN
051607

X ARMS PANELS

X4A (x2) + X5 + X2
022324

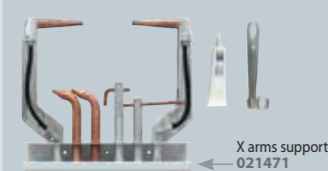

X4A (x2) + X4B + X4C + X2
020733

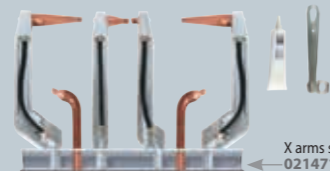

X arms support
021471

X arms support
021471

Remote control (BP)

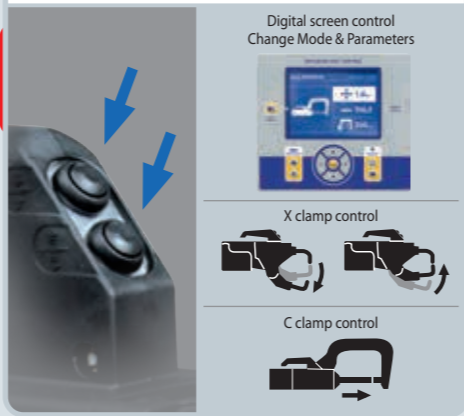

Digital screen control
Change Mode & Parameters

X clamp control

C clamp control

C ARMS PANELS



C2
+ C3
+ C4
019126



C2
+ C3
+ C4
021457



C2
+ C3
+ C4
060821



C2 + C3 + C6 + C12 + C9
= 061286
C2 + C3 + C6 + C12 + C9
= 061316

FOR GYSPOT BP-LCX, BP-LC, PTI

550 daN

6,5 kg including C1

- DOUBLE PRESSURE
- LIQUID COOLED / REFRIGERATION LIQUIDE
- Ø 10 mm



550 daN

Transformer inside

9,9 kg including C1

- DOUBLE PRESSURE
- AIR COOLED + LIQUID COOLED / DOUBLE REFRIGERATION AIR + LIQUID
- Ø 10 mm

Arm lock pin
062405



C Arms - Caps Ø13 mm

Classic arms



Bras isolés - Isolated arms - Isolierte Bügel

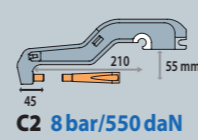

C2 8 bar/550 daN
022386
019133

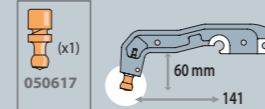

C6 8 bar/300 daN
022409
019775

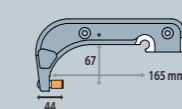

C12 8 bar/550 daN
022997

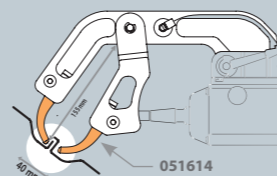

C10 4 bar/150 daN
051638

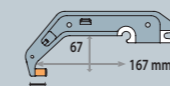

C5 8 bar/550 daN
022393
019294

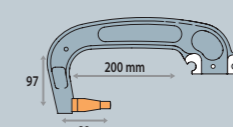

C1 8 bar/550 daN
021402

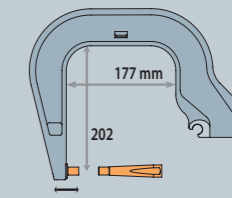

C8 8 bar/550 daN
021440
020016

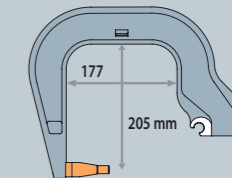

C3 8 bar/550 daN
021419

X Arms - Caps Ø13 mm

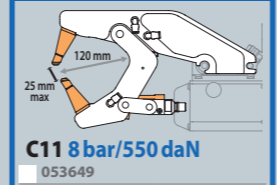

C11 8 bar/550 daN
053649

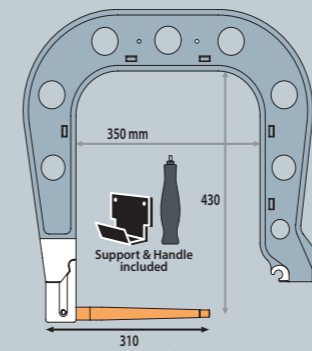

C7 8 bar/550 daN
021433
020009

Option for C7

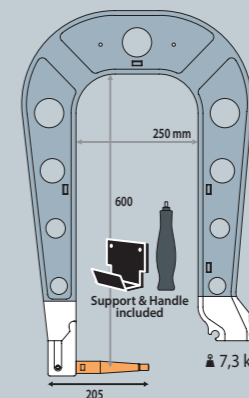

C9 8 bar/550 daN
020078

Option for C9 & C14

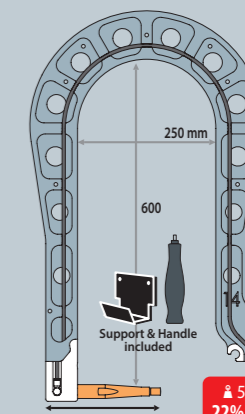
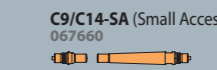

C14 8 bar/400 daN
023543

▲ 5,7 kg
22% saved

SPOT WELDING

GENIUS

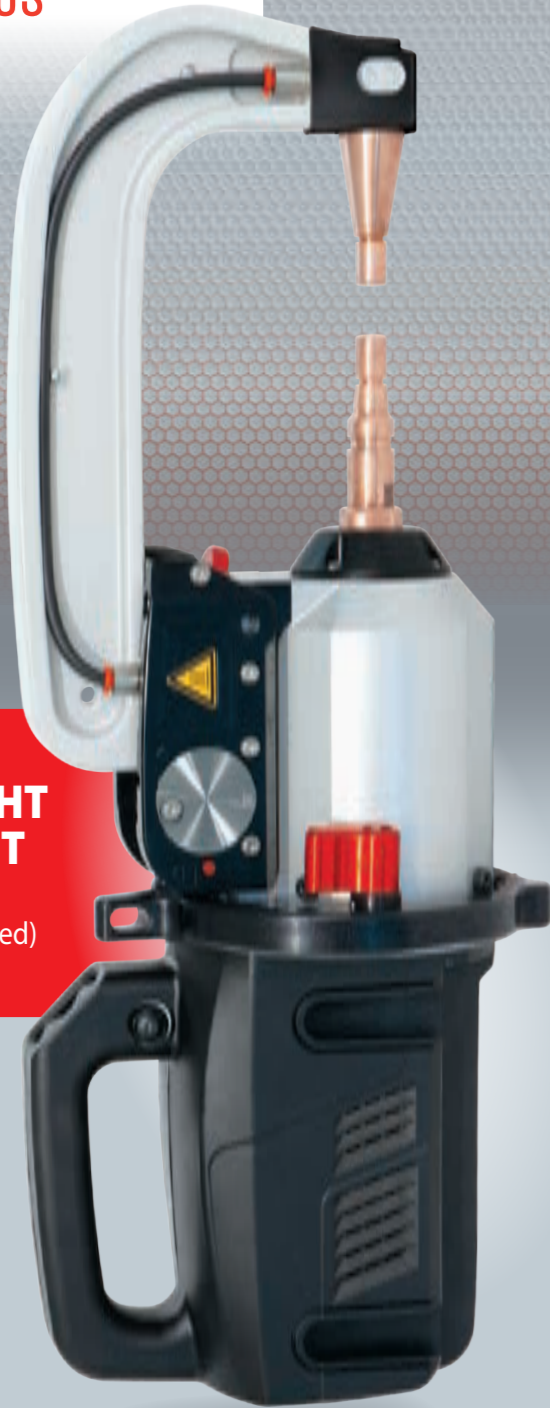

MADE IN FRANCE

ULTRA LIGHT & COMPACT

6.5 kg
(Gyro & G1 included)

550 daN



6.5 kg
(Gyro & G1 included)

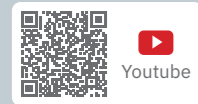

OPTIONS

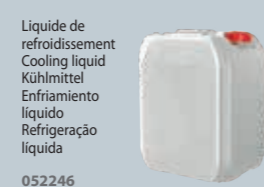

FAST OPEN XL

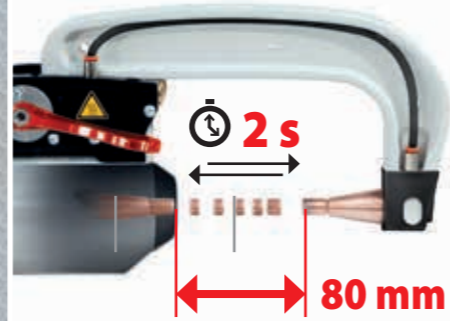

EASY



GYRO INTEGRATED

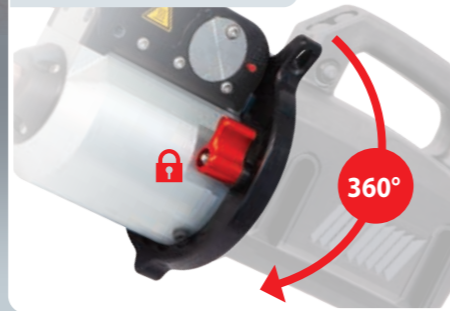

PERFECT ELECTRICAL CONNECTION



AUTO



GYSPOT INVERTER BP-LG

13 000 A
550 daN

For mild steel, HSS, UHSS Boron steel

BP BODYPROTECT
Unique electro-magnetic field protection by GYS

Traceability software
Save spot welding configuration and export data

023451

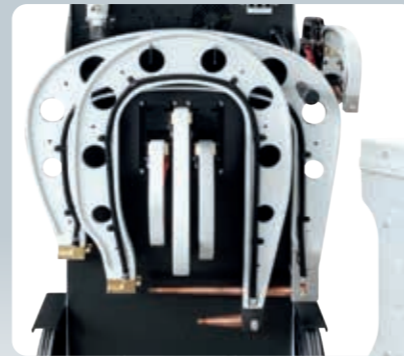

	023550	023451	023499
Gyspot BP-LG	220V	400V	
Monopoint/Spot 049291	▪	▪	▪
Spotter box pro (p.10) 050075	▪	▪	▪
Inertia hammer 049482 + 049802	▪	▪	▪
Caps remover 050846	▪	▪	▪
Arm support	▪	▪	▪
G1 022768	▪	▪	▪
G2 + G3 + G4 022898	▪	▪	▪
Liquid cooling (10) 052246			▪ (x3)

MADE IN FRANCE	CE NORM. 62135	50/60 Hz	-AM- A D curve	Spots/min (max) 2.5+2.5	I RMS A	Uo V	mm	Cables			100% CU	cm	kg	
								2.5m, Ø200mm ² , Liquid	2.5m, Ø150mm ² , air	8m 4x16mm ² (6AWG) 500W				
GYSPOT B.P.LG 220 V	3x	200	60 (21-25 kVA)	2	10 500	15	2.5+2.5+2.5	1.5+3	2.5m, Ø200mm ² , Liquid	2.5m, Ø150mm ² , air	8m 4x16mm ² (6AWG) 500W	OK	65 x 80 x 205	160
		220	80 (28-33 kVA)	6	11 000									
		240	100 (35-41 kVA)	10	12 000									
GYSPOT B.P.LG 400V	3x	400V	32 (22 kVA)	2	13 000	16	2.5+2.5+2.5	1.5+3	2.5m, Ø200mm ² , Liquid	2.5m, Ø150mm ² , air	8m 4x6mm ² H07RNF	OK	65 x 80 x 205	160
			40 (28 kVA)	6										
			50 (35 kVA)	10										

FAST OPEN XL

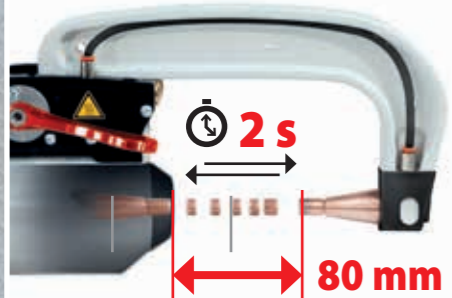

GYRO INTEGRATED



NEW



MADE IN FRANCE

PERFECT ELECTRICAL CONNECTION

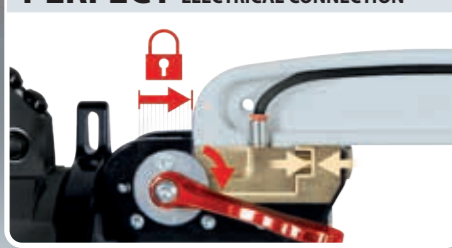

TRANSFORMER INSIDE

AUTO



550 daN
LIQUID COOLED
REFROIDISSEMENT LIQUIDE
Ø 10 mm
11.3 kg
(Gyro & G1 included)

**Potence électrique - Motorised cable support
- Elektrisch verstellbarer Kabelsupport**



Ergonomic

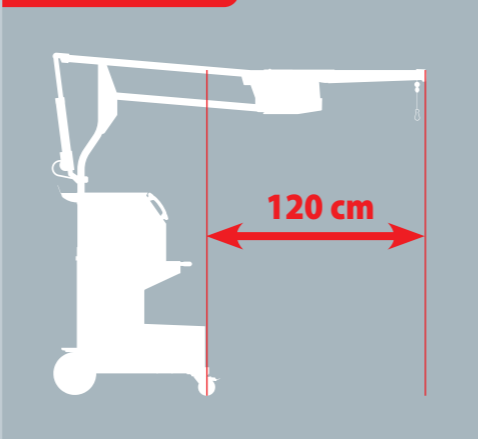

OPTIONS

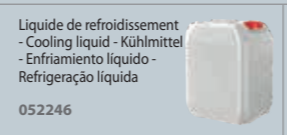

**GYSPOT INVERTER
PTI-G**

14 500 A
550 daN

For mild steel, HSS, UHSS **Boron steel**

TRANSFORMER INSIDE

Traceability software
Save spot welding configuration
and export data

	024854	024878	068001	024892
Gyspot PTI-G	220V	400V		480V
Caps remover 050846	■	■	■	■
Arm support	■	■	■	■
G1 022768	■	■	■	■
G2 + G3 + G4 022898			■	
Kit gun 067226			■	
Liquid cooling (10) 052246			(x3)	

Included
Cable support
**ULTRA
RESISTANT**



**ELECTRIC
MOTOR**

NEW

Control
Commande

6 m

**Grande stabilité
- High stability**

OPTIONS



MADE IN FRANCE 62135	50/60 Hz	-AM- A D curve	Spots/min (max) 2.5+2.5	RMS A	Uo V	mm			Cables		cm	kg
						2.5+2.5+2.5	1,5+3	6 m, Liquid	8 m 4xAWG8 (500W)			
GYSPOT PTI.G 220 V	3 x 200 208 220 240	50 (17-21 kVA)	20	12 500 13 000 14 500 14 500	6.6 6.9 7.3 7.9	2.5+2.5+2.5	1,5+3	6 m, Liquid	8 m 4xAWG8 (500W)	71 x 90 x 200	100	
GYSPOT PTI.G 400V	3 x 400V	25 (17 kVA)	20	14 500	7	2.5+2.5+2.5	1,5+3	6 m, Liquid	8 m 4x4 mm ² H07RN-F	71 x 90 x 200	100	
GYSPOT PTI.G 480V	3 x 480V	20 (17 kVA)	20	14 500	7	2.5+2.5+2.5	1,5+3	6 m, Liquid	8 m 4xAWG12 (500W)	71 x 90 x 200	100	

FOR GYSPOT BP-LG & PTI-G

G Arms - Caps Ø13 mm

Bras isolés - Isolated arms - Isolierte Bügel

NEW **Reversible**
for G1, G3, G4, G5, G8 & G10

Kit de maintenance connecteurs pince G - Connectors maintenance kit for G clamp 067295

(x1) 050617

G2
8 bar/300 daN
022775

051614

G6
8 bar/550 daN
022812

G7
4 bar/150 daN
022829

G1
8 bar/550 daN
022768

Option for G1 & G3

G1/G3-SA (Small Access)
067653 (for arms > 02/2021)

G3
8 bar/550 daN
022782

G4
8 bar/550 daN
022799

Option for G4

G4-SA (Small Access)
064478 (for arms < 01/2021)

G5
8 bar/550 daN
022805

Option for G5

G5/G10-SA (Small Access)
067660

G8
8 bar/550 daN
022836

Option for G8

G8-SA (Small Access)
067677

NEW

G10
8 bar/400 daN
067165

Option for G10

G5/G10-SA (Small Access)
067660

G > X
UNIQUE SYSTEM by GYS
AUTOMATIC WELDING FOR X1, X2 & X6

X1
(Included with G9) 050501
550 daN

X2 050518
X6 050587

Protections for G clamp & arms 067288

Option SD card 050914
Option PCB 97449C
90284 + 55121

G ARMS PANELS

G2 + G3 + G4
022898

G2 + G3 + G5
063297

CONSOUMMABLES X & C - X & C Consumables

Type A Cor X clamp Ø 13 mm (x6) 049987	Type D Cor X clamp Ø 13 mm (x10) 058507	TYPE G Ø 13 mm (x10) 059672	048935	050068
Type B Cor X clamp Ø 13 mm / Ø 5 mm (x6) 055506	TYPE F For single sided gun Ø 13 mm (x6) 049970	Caps inclinés - Beveled X2, X4, C11 arms Ø 13 mm (x6) 049994	x40 (x6: 049987)	x10 (x20: 052239) x6 (x6: 049994) x18 (x6: 049987) x18 (x6: 049970)
Graisse contact Contact grease 050440	Caps remover 050846	Europax anti-corrosion 052758	Monopoint / Spot 049291	

AFFUTEUR DE CAPS PNEUMATIQUE - Pneumatic cap grinder

061484

Lame - Blade 061491

Type A caps

AFFUTEUR DE CAPS - Cap grinder

Lame - Blade 052857

048966

Optimal speed: 400-800 rpm

Youtube

BANC DE TRACTION ARRACHE TÔLE - Steel sheet traction bench - Blech-Zugbank zur Festigkeitsprüfung

052420

052321 (included)

VALISE TEST SOUDURE HLE / THLE - Weld test kit - Schweißtestkit im Hartschalenkoffer

050433

Barre d'arrache / Traction bar + Acier doux / Mild steel 0.65 (x25) + 1.0 (x25) + Acier HSLA 360 - HLE 0.8 (x25) + 1.5 (x25) + Acier DP600 - THLE/UHLE 1.0 (x25) + Acier FB560 - THLE/UHLE 2.5 (x25)

PROTECTION ANTI-ARC 12 V - Anti-arc protection 12V - Lichtbogenschutz 12V - Protección anti-arco 12V

041318

GYRO 360°

for BPLC/BPLCX 051737

10-14 kg

for EVOLUTION 051720

ÉCHANTILLONS DE TÔLES - Sheets set

Acier standard / Standard steel 0.8 (x65) + 1 (x55) + 1.5 (x35) + 2 (x25) + Alu 1 (x45) + 1.5 (x30) + 2 (x20) 055841

CAPTEUR D'EFFORT - Electrode force sensor

052314

KIT DE PURGE RÉSERVOIR - Tank draining kit - Kit zur Tankentleerung

058286

for GYSPOT BP & PTI

CARTE MÉMOIRE SD - SD memory card

SD CARD 050914

KIT WIFI

for Gyspot Inverter PTI-G 070691

HOUSSE DE PROTECTION - Protection cover - Schutzhaube

for BP & PTI 050853

LIQUIDE DE REFROIDISSEMENT - Cooling liquid - Kühlmittel - Enfriamento líquido - Refrigeração líquida

052246



RIVETING

PNEUMATIC HYDRAULIC



OPTIONS

Support Riveteuse pour changements d'accessoires (bras & matrice)
- Riveting machine support for changing accessories (arms & dies)
- Supportständer
↳ 28 x 40 x 21,5 cm
054158

Chariot-Trolley
↳ 79 x 81 x 51 cm
↳ 80 x 15 x 123 cm
44 kg
054233

Chariot + Support Trolley + Support
↳ 51 x 122 x 74 cm
055391

Capteur d'effort 062115

Hydraulic body wrenches (x2) 067325

Serre-tôles - Temporary-fasteners manual mounting

(x10) Ø 2,4 mm 069664

(x10) Ø 4,0 mm 069671

(x10) Ø 4,8 mm 069688

(x10) Ø 6,4 mm 069695

NEW



UNIQUE
100%
No air inclusion
maintenance free, no oil refill

UNIQUE
PUSH PULL
SYSTEM by GYS

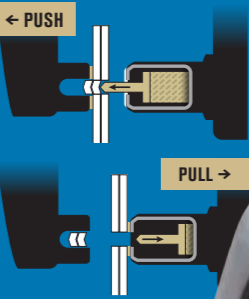

POWER
10t



POWER
10t

BRAS DE RIVETAGE - RIVETING ARMS - STANZNIETBÜGEL

HR110 063310	HR210 063327	HR310 8T 065963	HR310 8T PP/10T/10T PP 063334
included XT31-92 (92 mm) 057128	included XT31-78 (78 mm) 058637		
GYSPRESS 8T	✓	✓	—
GYSPRESS 10T	✓	✓	✓
GYSPRESS 8T PUSH PULL	✓	✓	✓
GYSPRESS 10T PUSH PULL	✓	✓	✓
GYSPRESS 10T CONNECT	✓	✓	✓



KIT HR210 + HR310 8T
065970

KIT HR210 + HR310 8T PP/10T/10T PP
064089

XT31-40 Rallonges bras HR310 pour point milieu - HR310 arm extension for middle point

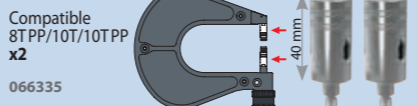

Compatible 8T PP/10T/10T PP x2
066335

GYPRESS COMPLETE PACKS

GYSPRESS 10T 063303	063310	058644	053694	048706	064089	064867	066076	055391
GYSPRESS 10T pack 1 066441								
GYSPRESS 10T pack 2 066458								
GYSPRESS 10T pack 3 064744								
GYSPRESS 10T PUSH PULL 063853								
GYSPRESS 10T PP pack 1 066465								
GYSPRESS 10T PP pack 2 066472								
GYSPRESS 10T PP pack 3 065789								

GYPRESS 10T

6.5 bar 100 kN

10t

063303

070653 NEW



GYPRESS 10T PUSH PULL

6.5 bar 100 kN

10t

063853

070660 NEW

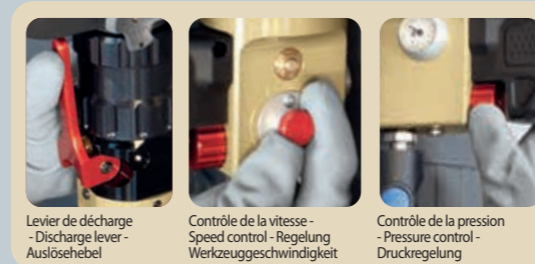

	AIR BAR	PRESSURE CONTROL	SPEED CONTROL	↕	⚖	↕	⚖	
				cm	kg	cm	kg	
MADE IN FRANCE	GYSPRESS 10T	6.5 bar = 10 t (maxi 10 bar)	0 > 6.5 bar	+ -	39.5 x 180	6.2 (HR110 included)	58 x 48 x 15	11.8
	GYSPRESS 10T PUSH PULL	6.5 bar = 10 t (maxi 10 bar)	0 > 6.5 bar	+ -	39.5 x 180	6.7 (HR110 included)	58 x 48 x 15	12.5



GYPRESS

SYNERGIC RIVETING WORKSTATION

PNEUMATIC HYDRAULIC



UNIQUE 100%
No air inclusion
maintenance free, no oil refill

ACCESSIBILITY

10 languages

- FR ES CN
- GB CZ JP
- DE NL
- IT RU

★★★★
SYNERGIC RIVETS SETTINGS

Main panel

Setup instructions



Results



3 MODES

- MANUAL
- SYNERGIC
- CAR MANUFACTURERS

CAR MANUFACTURERS COMPATIBILITY

- ✓ VW GROUP
- ✓ MERCEDES-BENZ
- ✓ BMW
- ✓ TESLA
- ✓ FERRARI
- ✓ FORD
- ✓ JAGUAR/ LAND ROVER
- ✓ GM

CONNECTIVITY

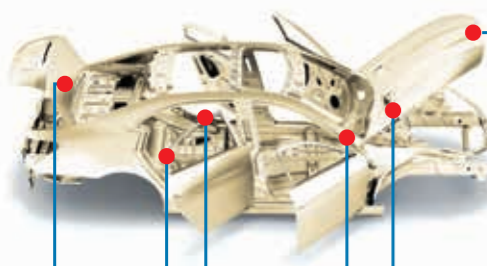

TRACEABILITY

History data export

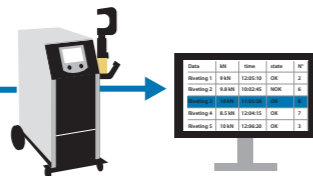

SOFTWARE UPDATE

Gyspress evolutions

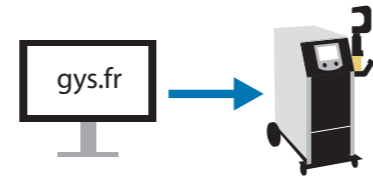

UNIQUE PUSH PULL SYSTEM by GYS

PUSH PULL SYSTEM by GYS

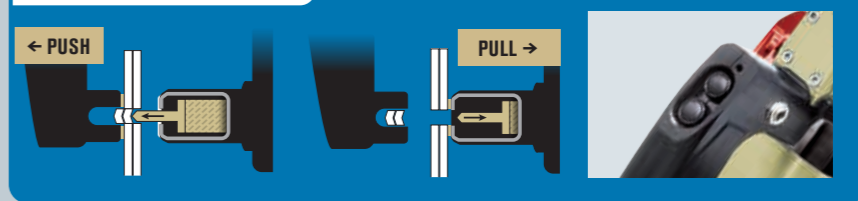

Sélection Push/Pull - Push/Pull selection

Gyspress support



Arms support



NEW 08/2021

REGULATED PRESSURE CONTROL

POWER 10t

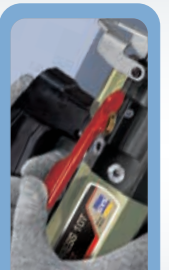

Levier de décharge - Discharge lever - Auslöshebel



WORKSTATION GYPRESS 10T PP CONTROL

6.5 bar 100 kN

10t

063860

included

- HR110 063310
- XT11.21 - Extension for HR110 & HR210 058644
- Standard 10T PushPull tool box 058361
- 6 x 50 rivets RAP - Nieten SPR 048706
- Strap-Sangle-Gurt
- HR arm locker
- Poignée-Handle-Griff

OPTIONS

Capteur d'effort for GYPRESS 10T, 8T & 10T PushPull, 10T PP CONTROL 062115



Youtube

Hydraulic body wrenches for GYPRESS 10T, 10T PushPull, 10T PP CONTROL (x2) 067325

MADE IN FRANCE WORKSTATION GYPRESS 10T PP CONTROL	230 V	AIR BAR 6.5 bar = 10 t (maxi 10 bar)	PRESSURE CONTROL 0 > 6.5 bar	SPEED CONTROL + -	cm	kg
					N/A	N/A (HR110 included)



ADAPTATEURS POUR RIVETS AVEUGLES - BLIND RIVET ADAPTERS



GYPESPRESS

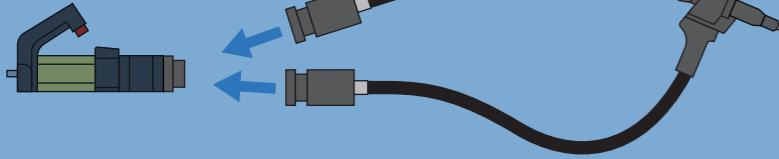

Compatibility	24 kN	50 kN
GYPESPRESS 8T	✓ (20 kN)	✓ (40 kN)
GYPESPRESS 10T	✓ (24 kN)	✓ (50 kN)
GYPESPRESS 8T PUSH PULL	✓ (20 kN)	✓ (40 kN)
GYPESPRESS 10T PUSH PULL	✓ (24 kN)	✓ (50 kN)
GYPESPRESS 10T CONNECT	✓ (24 kN)	✓ (50 kN)

ADAPTATEUR 24 KN POUR RIVETS AVEUGLES - Blind rivet adapter 24 kN - Blindnietadapter 24 kN

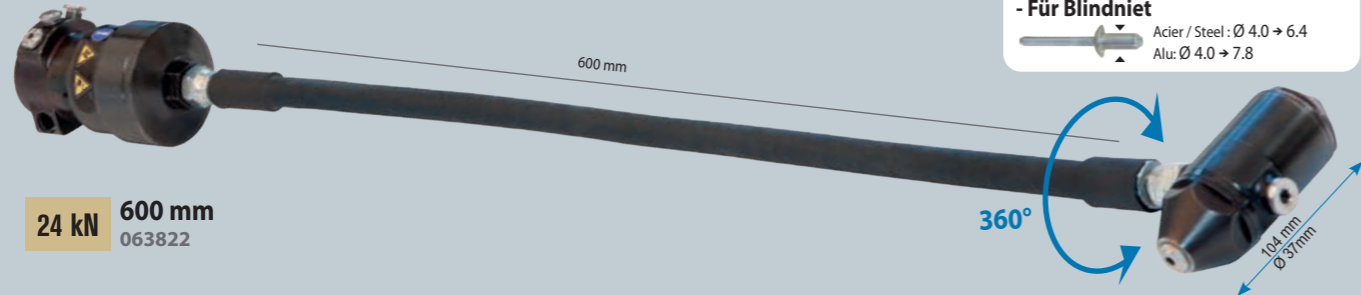

24 kN 600 mm
063822

Pour rivets POP - For BLIND rivets - Für Blindniet

Acier / Steel : Ø 4.0 → 6.4
Alu: Ø 4.0 → 7.8

HIGH ACCESSIBILITY



SPECIFIC STORAGE



INCLUDED

for standard rivets:

Ø 3.2 x1	059221		058446
Ø 3.6 x1	059238		
Ø 4.0 x1	059245		
Ø 4.5 x1	059252		

PERFECT COMBO WITH ARC PULL

SPÉCIAL ARRACHAGE DE RIVETS
Special tearing rivets - Spezial-Zugnieten



OPTION ADAPTERS

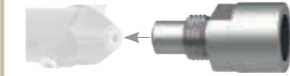

for 24 KN ADAPTER
Buse pour extraction de rivets RAP Ø4
- Extraction nozzle for Ø4 SPR rivets
064683

for 50 KN ADAPTER
Buse pour extraction de rivets Ø 4 & 5
- Extraction nose-piece Ø 4 & 5
066151

OPTION FOR GYSPOT ARC PULL (details p.15)



for GYSPOT ARCPULL 350

ARC PULL RIVET BOX 350
064584

Tige inox - Stainless steel nail Ø 4 x 50 mm	Canon pour pose de tige inox - Barrel for stainless steel nail welding	Support porte-goujon - Mandrel support	Buse + patin - Nozzle + pad	mandrel Ø4mm
064607	059634	059641	049000	
×100	×1	×1	×1	×1

for GYSPOT ARCPULL 700

ARC PULL RIVET BOX 700
068452

Ø 5 x 50 mm	Canon long + mandrin M5 - Long barrel + mandrel M5	Support porte-goujon - Mandrel support	Buse + patin - Nozzle + pad	Ring holder	Masse - Earth
070745	070738	071377	059641	059610	071384
×100	×1	×1	×1	×2	×1

ADAPTATEUR 50 KN POUR RIVETS AVEUGLES - Blind rivet adapter 50 kN - Blindnietadapter 50 kN



50 kN 1 m
064867
▲ 4.0 kg

Réglage de la course de traction - Stroke adjustment
0 → 25 mm

Pour rivets POP - For BLIND rivets - Für Blindniet

Acier / Steel : Ø 4.0 → 6.4
Alu: Ø 4.0 → 7.8

INCLUDED

Kit Standard



+ Complete kit 065987



OPTIONS

Acier / Steel : Ø 4.0 → 6.4
Alu: Ø 4.0 → 7.8

Extension 160 mm - 160 mm extension - Verlängerung 160 mm
066144

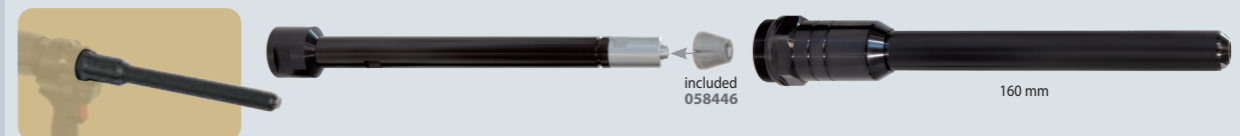

Ø 8.0 → 9.8

Kit Rivets Ø8.0/9.8mm - Ø8.0/9.8mm noze-piece kit - Mundstückkit 8,0/9,8 mm
066045



M5 → M14
M5 → M8

Kit 6 tirants pour pose d'écrous à sertir - Blind rivet nut pulling adapter kit - Blindnietmuttern-Kit
066076



	M5	066083
	M6	066090
	M8	066106
	M10	066113
	M12	066120
	M14	066137

BOÎTE CONSOMMABLES POUR ADAPTATEUR 50KN - Consumables box for 50kN adapter - Zubehörbox für 50 kN Adapter

066168



Écrous à sertir - Blind rivet nuts

	M5		M6		M8		M10		M12		M14
22.5 → 27	24 → 28.5	23.5 → 28	0.5 → 3.0	0.5 → 3.0	0.5 → 3.0	1.0 → 3.5	1.0 → 4.0	4.5 → 6.0			
x50	x50	x50	x50	x50	x50	x50	x50	x10			
066175	066182	066199	066205	066212	066229						

+ plaque de démonstration - demo metal sheet

×10 ×10 ×10 ×10 ×10 ×5

Goujons à sertir - Blind rivet bolts

	M5		M6		M8
22.5 → 27	24 → 28.5	23.5 → 28	0.5 → 3.0	0.5 → 3.0	0.5 → 3.0
x50	x50	x50			
066236	066243	066250			

+ ×10 ×10 ×10

Rivets aveugles - Blind rivets

	Ø 6.4		Ø 9.8
2.8 → 4.8	3.0 → 14.0		
x50	x50		
066267	066274		

+ ×10 ×10



MATRICES - Dies - Matrizen

Pose de rivets auto-perçants
- Application of self-piercing rivets
- Stanzniet-Verpressen

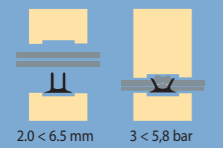

Pose de rivets pleins
- Application of solid rivets
- Vollniet-Verpressen

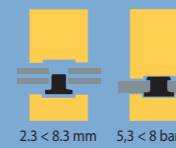

Pose de rivets Flow-Form
- Application of Flow-form rivets
- Setzen v. Fließformnieten

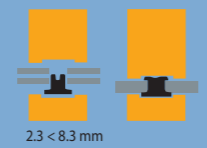

Extraction de rivets
- Extraction of rivets
- Niet-Auspressen

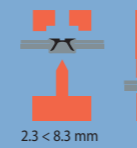

Perçage et formage des tôles pour rivets pleins - Metal sheet punching and shaping - Vollniet-Lochstanzen/Prägen

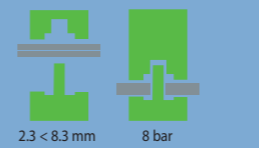

x1	x1	x1	x1	x1	x1	x1	x1	x1	x1	x1	x1	x1	x1	x1	x1	x1	x1	x1	x1	x1	
A1	A2	B1	B2	B3	B4	B5	B6	D1	D2	D3	D4	D5	D6	D7	D8	D9	D10	D11	D12	D13	
055698	055704	055711	055728	055735	059016	059023	059030	055971	055988	055995	055742	056008	056015	056022	056039	056046	055674	056060	056053	055759	
A1+A2		B1+B2																			
054295		054301																			

x1	x1	x1	x1	x1	x5	x1	x1	x1	x1	x1	x1	x1	x1	x1	x1	x1	x1	x1	x1	x1			
D15	D16	D17	D18	E1	E2	E3	E4	E5	E6	E7	E8	E9	E10	E11	E12	E13	F1	F2	F3	F4			
056077	056084	055681	071155	055865	054288	055766	057005	057012	057029	057142	057159	057166	058606	058613	058620	058828	059085	055773	055780	055797	055803		
				E1+E2																F1+F2			
				054318																054714			

x1	x1	x1	x1	x1	x1	x1	x1	x1	x1	x1	x1	x1	x1	x1	x1	x1	x1	x1
F5	F6	G1	G2	G3	G4	G5	G6	H1	H2	H3	H4	H5	H6	H7	H8	I1	I2	I3
055810	071148	057173	057180	057197	057203	057210	057227	068230	068247	068254	068261	068278	068285	068292	068308	071117	071124	071131

x1	x1	x1	x1	x1	x1	x1	x1	x1	x1	x5	x1	x1	x1	x1	x1	x1	x1	x1	
S1	S3	S4	S5	S7	S8	ST1	ST2	ST3	T1	T2	T3	T4	T5	T7	T8	T10	T12	T13	
057036	057043	057050	057067	057074	057081	058071	058088	066397	057098	059078	057104	055827	055834	058019	058033	058040	058064	066373	066380
										T1+T2									
										054707									

BREVET GYS
GYS PATENT

x1	x1	x5	x1	x1	x1	x5	x1	x1			
T14	T15	T16	T17	T18	T19	T20	T21	T22			
066410	066427	068964	066434	069312	069329	071254	069336	070936	070943	071261	070950

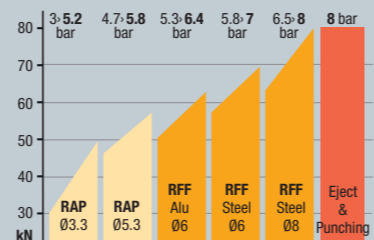

RIVETS AUTOPERÇANTS (RAP)
- Self piercing rivets (SPR) - Stanznieten

Steel - Acier - Stahl

Complete box 048706							
x200	x200	x100	x100	x100	x100	x100	x100
048232	048249	048256	048263	048270	048225	048638	048645

POINTEAU CENTREUR
- Special center punch - Spezialkörner

048379

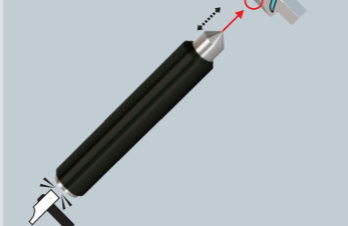

RIVETEUSE HYDRO-PNEUMATIQUE - Hydropneumatic tool for blind rivets - Hydro-pneum. Blindnietgerät

HR9

Pour rivets POP - For BLIND rivets - Für Blindniet
Acier / Steel Ø 3.2/4.0/4.8
Alu Ø 3.2/4.0/4.8

max 9 000 N

057234

Made in Taiwan



RIVETEUSE HYDRO-PNEUMATIQUE - Hydropneumatic tool for blind rivets - Hydro-pneum. Blindnietgerät

HR14

Pour rivets POP - For BLIND rivets - Für Blindniet
Acier / Steel Ø 4.0/4.8/6.4
Alu Ø 4.0/4.8/6.4

max 14 000 N

057241

Made in Taiwan



RIVETEUSE SUR BATTERIE - Cordless riveter - Akku-Blindnietgerät

TWO ER20 064461

Pour rivets POP - For BLIND rivets - Für Blindniet
Ø 4.0/4.8/5.0/6.0/6.4

max 20 000 N (6 bar)

10-20 V universal fast charger (30 min)
2.0 kg



2 x
20V/2Ah Li-ion battery

RIVETEUSE MANUELLE - Manual tool for blind rivets - Manueller Blindnietgerät

Pour rivets POP - For BLIND rivets - Für Blindniet

Acier / Steel Ø 3.2/4.0/4.8/6./6.4
Alu Ø 3.2/4.0/4.8/6./6.4

061323

Made in Taiwan



SERTISSEUSE HYDRO-PNEUMATIQUE RIV 998 - Hydropneumatic tool for rivet nuts - Hydro-pneum. Blindnietmutterngerät

RIV 998

Ecrous à sertir - Sealing nuts - Blindnietmuttern

Pour la pose d'écrous à sertir M3 à M12
For sealing nuts from M3 to M12

max 19 000 N (6 bar)
livré avec accessoires pour écrous à sertir:
- included accessories for sealing nuts:

- ✓ M3
- ✓ M4
- ✓ M5
- ✓ M6
- ✓ M8
- ✓ M10
- ✓ M12

055414



MADE IN ITALY

RIVETEUSE HYDRO-PNEUMATIQUE - Hydropneumatic tool for blind rivets - Hydro-pneum. Blindnietgerät

HR21

Pour rivets POP - For BLIND rivets - Für Blindniet
Ø 4.0 → 7.8

max 21 000 N (6 bar)

055407



- included (x3) 058446
- For standard rivets Ø 4.0 51508
- For Magnarive rivets Ø 4.5 51507



MADE IN ITALY

Option HR21 extension 100 mm 063105



AUTOGYS

GMAW MIG/MAG SYNERGIC



CARMIG

15 **200 A**

400V • 3~

with accessories
032132

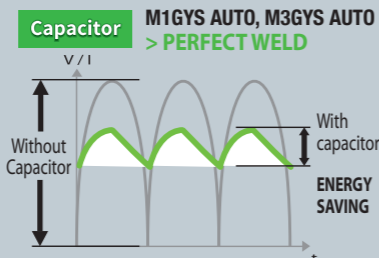

Capacitor M1GYS AUTO, M3GYS AUTO
> PERFECT WELD

Without Capacitor
With capacitor
ENERGY SAVING

M1 GYS AUTO

15 **160 A** Capacitor

230V • 1~
with accessories
032903

208/240V • 1~
with accessories
032088

T1 GYS AUTO

15 **200 A**

400V • 3~
with accessories
032910

T1 GYS AUTO DV

15 **200 A**

230V • 3~ / 400V • 3~
with accessories
032927

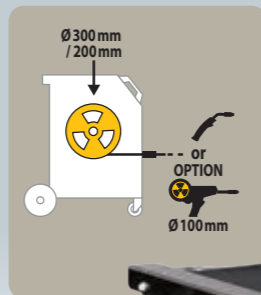

SYNERGIC - EASY TO USE
Réglage automatique de la vitesse \ Auto adaptative wire speed
Automatische Einstellung der Drahtgeschwindigkeit

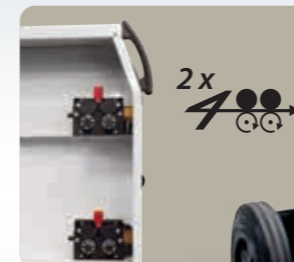
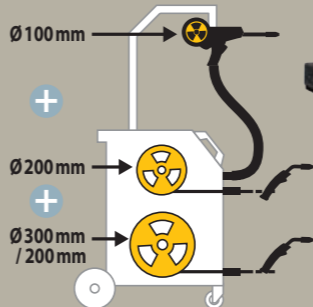

Acier/Steel, 3 m
063754

Échantillons de tôles
- Sheets set

Acier standard/
Standard steel
0,8 (x65) + 1 (x55)
+ 1,5 (x35) + 2 (x25)
+ Alu
1 (x45) + 1,5 (x30)
+ 2 (x20)
055841

M3 GYS AUTO

15 **160 A** Capacitor

230V • 1~
with accessories:
032880

T3 GYS AUTO

15 **200 A**

400V • 3~
with accessories:
032958

with accessories:
032941

T3 GYS AUTO DV

15 **200 A**

230V • 3~ / 400V • 3~
with accessories:
032972



2 x 4m³
(20L)



câble secteur -
mains cable
6m

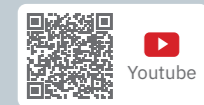

AUTOGYS

GMAW FCAW
CARBODY SYNERGIC MIG

63

OPTIONS

Torche motorisée Spool Gun
- Spool Gun Torch - Spool Gun Brenner



041486

Ø 100
Ideal for
- Acier / Steel / Stahl
- Inox / Stainless steel
- Alu

included
045699

SPOOL GUN + Support
for M3 & T3 GYS AUTO
038554

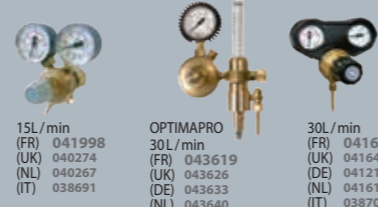

15L / min
(FR) 041998
(UK) 040274
(NL) 040267
(IT) 038691

OPTIMAPRO
30L / min
(FR) 043619
(UK) 043626
(DE) 043633
(NL) 043640

30L / min
(FR) 041622
(UK) 041646
(DE) 041219
(NL) 041615
(IT) 038707

041332



T3GYS & M3GYS :
Housse de
protection
- Protection cover
- Schutzhaube
052260



MB 15 (150A)
041226

x3
x5
x5 (M6-Ø0,6)
x5 (M6-Ø0,8)
x5 (Alu -
M6-Ø0,8)

041806

Protection gas
Argon+CO₂ (Steel, Inox)
Argon (ALU/CuSi3/CuAl8)
CO₂PUR (Steel)

MADE IN FRANCE	MADE IN CHINA	NORM. 60974/1	50/60 Hz	A	min → max	Reg	100 (spoolgun)	200	300	Electronic Control	EN60974-1 (40°C)			cm/kg	Protected & compatible power generator (+/-15%)		
											IA (60%)	X% (I2 max)	Ø mm				
■	■	■	400V 3~	10	15 → 200	7	-	■	■	electronic	110	150A@25%	0,6+1	0,6/0,8	0,8	47x77x79 / 50	5 kVA
■	■	■	230V 1~ 208/240V 1~	16	15 → 160	6	option	■	■	400V	90	140A@15%	0,6+1	0,6/0,8	0,8	47x77x79 / 46	4,5 kVA
■	■	■	400V 3~	10	15 → 200	7	option	■	■	400V	110	150A@25%	0,6+1	0,6/0,8	0,8	47x77x79 / 52	5.2 kVA
■	■	■	230V 3~/400V 3~	10	15 → 200	7	option	■	■	400V	110	150A@25%	0,6+1	0,6/0,8	0,8	47x77x79 / 52	5.2 kVA
■	■	■	230V 1~ 208/240V 1~	16	15 → 160	6	■	■	■	400V	90	140A@15%	0,6+1	0,6/0,8 0,8/1,0	2 x 0,8	60x90x90 / 58	4,5 kVA
■	■	■	400V 3~	10	15 → 200	7	■	■	■	400V	110	150A@25%	0,6+1	0,6/0,8 0,8/1,0	2 x 0,8	60x90x90 / 75	5.2 kVA
■	■	■	230V 3~/400V 3~	10	15 → 200	7	■	■	■	400V	110	150A@25%	0,6+1	0,6/0,8 0,8/1,0	2 x 0,8	60x90x90 / 75	5.2 kVA

62



GMAW MIG/MAG INVERTER • SYNERGIC

4 in 1

GAS	NO GAS
MMA	TIG



MULTEPEARL 210-2

200 A ⚡ ⌀ 100/200

P400 PFC FV SR

GAS	NO GAS	MMA	TIG
-----	--------	-----	-----

3 m 2.5 m, 16 mm² 2 m, 16 mm²

065093

MULTEPEARL 210-4 XL

200 A ⚡ ⌀ 200/300

P400 PFC FV SR

GAS	NO GAS	MMA	TIG
-----	--------	-----	-----

3 m 2.5 m, 16 mm² 2 m, 16 mm²

065109

MULTEPEARL 211-4

200 A ⚡ ⌀ 200/300

P400 PFC FV SR

GAS	NO GAS	MMA	TIG
-----	--------	-----	-----

3 m 2.5 m, 16 mm² 2 m, 16 mm²

065116

PFC POWER FACTOR CORRECTION

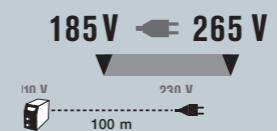

FV FLEXIBLE VOLTAGE

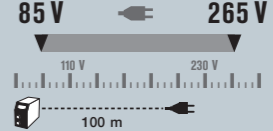

SR SECONDARY REGULATION

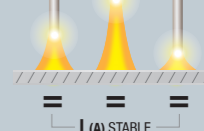

1 MIG / MANUAL



2 MIG / SYNERGIC



- Select :
- material
 - Ø wire
 - position
 - thickness
- Adjust arc length
- | | |
|-------|--------|
| Fe | CrNi |
| AlMg5 | CuSi3 |
| AISI5 | AISI12 |
| CuAl8 | F.C. |

3 MMA



4 TIG lift



PFC EN 61000-3-12 FV FLEXIBLE VOLTAGE

PFC EN 61000-3-12 FV FLEXIBLE VOLTAGE

PFC EN 61000-3-12 FV FLEXIBLE VOLTAGE



NO GAS

KIT SOUDAGE NO GAZ Ø 0.9
- No Gas Welding Kit Ø 0.9
- Schweißset Fülldraht

TYPE A
MultiPearl 200-2 only
041240

TIG torch kit SR17V (valve)
4 m
10/25 mm²
044425



TIG torch kit SR17 DB
4 m
046108



MADE IN FRANCE EN60974-1	50 / 60 Hz	I ₂			min → max	EN60974-1 (40°C)		U ₀ (V)	MIG			Ø mm	Equipment d'origine Original equipment Originalausstattung Equipamiento de fabrica	ELECTRONIC CONTROL	cm	kg	Protected & compatible power generator (+/-15%)		
		A	A	A		IA (60%)	X% (I2 max)		max	Ø mm	Ø mm								
MULTIPEARL 210-2	110V 1~	32	20 → 130	20 → 180	20 → 150	100	150 A @ 22%	75	15	■	■	—	0.6 + 1.0	0.9 + 1.2	1.6 + 3.2	Type A 0.8	25 x 45 x 35	16	7.5 kW
	230V 1~	13	20 → 200	20 → 200	20 → 200	130	200 A @ 20%	76	—	■	■	■	0.6 + 1.0	0.9 + 1.2	1.6 + 5.0	—	—	—	—
MULTIPEARL 210-4 XL	110V 1~	32	20 → 130	20 → 180	20 → 150	100	150 A @ 22%	75	15	—	■	■	0.6 + 1.0	0.9 + 1.2	1.6 + 3.2	Type B 0.8	25 x 55 x 44	20	7.5 kW
	230V 1~	13	20 → 200	20 → 200	20 → 200	130	200 A @ 20%	76	—	■	■	■	0.6 + 1.0	0.9 + 1.2	1.6 + 5.0	—	—	—	—
MULTIPEARL 211-4	110V 1~	32	20 → 130	20 → 180	20 → 150	100	150 A @ 22%	75	15	—	■	■	0.6 + 1.0	0.9 + 1.2	1.6 + 3.2	Type B 0.8	41 x 73 x 77	37	7.5 kW
	230V 1~	13	20 → 200	20 → 200	20 → 200	130	200 A @ 20%	76	—	■	■	■	0.6 + 1.0	0.9 + 1.2	1.6 + 5.0	—	—	—	—



AUTOPULSE

GMAW MIG/MAG INVERTER DOUBLE PULSE

Latest generation colour screen 5" 800 x 480 (WVGA)



ACCESSIBILITY

- 3 interface levels
- 10 languages
- EASY
- EXPERT
- ADVANCED
- French
- English
- German
- Italian
- Spanish
- Czech
- Dutch
- Russian
- Chinese
- Japanese

1 EASY



3 INTERFACE LEVELS

2 EXPERT



3 ADVANCED



500+ JOBS can be saved



TRACEABILITY



PORTABILITY

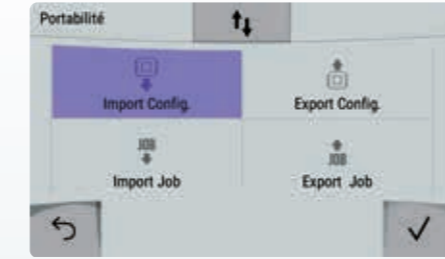

MODES

- DYNAMIC STANDARD
- PULSE
- PULSE IN PULSE
- MANUAL
- COLD PULSE

FULLY DIGITAL

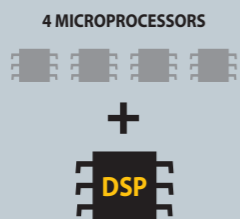

65+ SYNERGIES



UPDATES

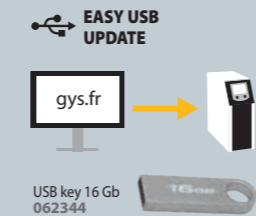

OPTIONS

PUSH PULL TORCH 24 V



MB 15 4m 044111
MB 25 4m 046283

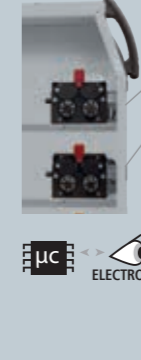

AUTOPULSE 220-M1		AUTOPULSE 220-M2	
1	Ø 200 / 300	1	Ø 200 / 300
-	-	2	Ø 200 / 300

AUTOPULSE 220-M1		AUTOPULSE 220-M2	
1	Ø 200 / 300	1	Ø 200 / 300
-	-	2	Ø 200 / 300

AUTOPULSE 220-M1

15 220 A 230V 1~ PFC

with accessories:

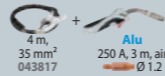

065024

AUTOPULSE 220-M1 208-240V

15 220 A 208>240V 1~ PFC

with accessories:



070868



AUTOPULSE 220-M2

15 220 A 230V 1~ PFC

with accessories:

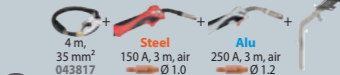

069855

AUTOPULSE 220-M2 208-240V

15 220 A 208>240V 1~ PFC

with accessories:



069862



PFC POWER FACTOR CORRECTION

185 V - 265 V

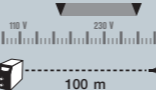

220 A • x 1

220 A • x 2

MADE IN FRANCE EM60974-1	50 / 60 Hz	A	Ø mm	min → max	SPOOLGUN	PUSH/PULL	200 300	Cooling system	EQUIPEMENT D'ORIGINE Original equipment Originalausstattung Equipamiento de fabrica	EN60974-1 (40°C)	IA (60%)	X% (12 max)	cm / kg	Protected & compatible power generator (+/-15%)
AUTOPULSE 220-M1	230 V · 1 ~	8 m	16	0.6 + 1.2	15 + 220	-	OPTION	Air	ALU : Type B 1.0 / 1.2	150	220 A @ 20%	88x93x63 / 69	10 kVA	
AUTOPULSE 220-M1 208-240V	208 > 240 V · 1 ~	8 m	16	0.6 + 1.2	15 + 220	-	OPTION	Air	ALU : Type B 0.8 / 1.0 mm	150	220 A @ 20%	88x93x63 / 69	10 kVA	
AUTOPULSE 220-M2	230 V · 1 ~	8 m	16	0.6 + 1.2	15 + 220	-	OPTION	Air	ALU : Type B 1.0 / 1.2	150	220 A @ 20%	88x93x63 / 69	10 kVA	
AUTOPULSE 220-M2 208-240V	208 > 240 V · 1 ~	8 m	16	0.6 + 1.2	15 + 220	-	OPTION	Air	ALU : Type B 1.0 / 1.2	150	220 A @ 20%	88x93x63 / 69	10 kVA	

AUTOPULSE INVERTER PULSE MIG



GMAW MIG/MAG INVERTER DOUBLE PULSE

BODYSHOP SPECIFIC
COLD PULSE
CuSi3 Ø 0.8/1



2 x 4 m³ (20L)
3 x

8 m

PFC POWER FACTOR CORRECTION
185 V ← 265 V

100 m

AUTOPULSE 220-M3			
1			
2			-
3			-

TESLA APPROVED EQUIPMENT

LC ELECTRONIC

AUTOPULSE 220-M3

15 220 A 230V 1~ **PFC**

with accessories:

4 m, 35 mm² 043817 + CuSi 150 A, 3 m, air Ø 1.0 + Steel 150 A, 3 m, air Ø 0.8 + Alu 250 A, 3 m, air Ø 1.2

036703

AUTOPULSE 220-M3 208-240V

15 220 A 208>240V 1~ **PFC**

with accessories:

4 m, 35 mm² 043817 + CuSi 150 A, 3 m, air Ø 1.0 + Steel 150 A, 3 m, air Ø 0.8 + Alu 250 A, 3 m, air Ø 1.2

062481

OPTIONS

PUSH PULL TORCH 24 V

Motor inside

MB 15 4m 044111
MB 25 4m 046283

Débimètre de bout de torche 053939

Housse de protection - Protection cover - Schutzhaube 052260

x5 (Mg-Ø 0.6)
x5 (Mg-Ø 0.8)
x5 (Mg-Ø 1.0)
x5 (Alu - Mg-Ø 0.8)

x5 (Mg-Ø 1.0)
x5 (Alu - Mg-Ø 1.0)
x5 (Alu - Mg-Ø 1.2)

AUTOPULSE 320-T1				AUTOPULSE 320-T3				AUTOPULSE 320-T3 208-240V			
1				1				1			
2	-	-	-	2				2			
3	-	-	-	3			-	3			-

TESLA APPROVED EQUIPMENT

LC ELECTRONIC

AUTOPULSE 320-T1

15 320 A 400V 3~ **PFC**

with accessories:

4 m, 35 mm² 043817 + Alu 250 A, 3 m, air Ø 1.2

069831

AUTOPULSE 320-T1 208-240V

15 320 A 208>240V 3~ **PFC**

with accessories:

4 m, 35 mm² 043817 + Alu 250 A, 3 m, air Ø 1.2

069848



10 m³ (50L)
1 x

5 m

5 m

NEW
3 x

OPTIONS

for AUTOPULSE 320-T3 (400 V) only

SPOOLGUN TORCH

Ideal Alu

Ø 0,8

4 m 041486

Motor inside



AUTOPULSE 320-T3 Old design 036710

AUTOPULSE 320-T3

15 320 A 400V 3~ **PFC**

with accessories:

4 m, 35 mm² 043817 + Steel 250 A, 3 m, air Ø 1.0 + Steel 250 A, 3 m, air Ø 0.8 + Alu 250 A, 3 m, air Ø 1.2

067615

AUTOPULSE 320-T3 208-240V

15 320 A 208>240V 3~ **PFC**

with accessories:

4 m, 35 mm² 043817 + Steel 250 A, 3 m, air Ø 1.0 + Steel 250 A, 3 m, air Ø 0.8 + Alu 250 A, 3 m, air Ø 1.2

036970

220 A • x 3

320 A • x 1

320 A • x 3

MADE IN FRANCE EN60974-1	50 / 60 Hz	A	Ø mm	min → max	SPOOLGUN	PUSH/PULL	200	Cooling system	Equipement d'origine Original equipment Originalausstattung Equipamiento de fabrica			EN60974-1 (40°C)	cm / kg	Protected & compatible power generator (+/-15%)
									⊗ ELECTRONIC CONTROL	IA (60%)	X% (I2 max)			
AUTOPULSE 220-M3	230 V · 1~	8 m	16	0.6 → 1.2	15 → 220	-	OPTION	Air		ACIER : Type B 0.8 / 1.0 mm ALU : Type B 1.0 / 1.2	150	220 A @ 20%	88x93x63 / 69	10 kVA
AUTOPULSE 220-M3 208-240V	208 > 240 V · 1~	8 m	16	0.6 → 1.2	15 → 220	-	OPTION	Air		ACIER : Type B 0.8 / 1.0 mm ALU : Type B 1.0 / 1.2	150	220 A @ 20%	88x93x63 / 69	10 kVA

MADE IN FRANCE EN60974-1	50 / 60 Hz	A	Ø mm	min → max	SPOOLGUN	PUSH/PULL	200	300	Cooling system	Equipement d'origine Original equipment Originalausstattung Equipamiento de fabrica			EN60974-1 (40°C)	cm / kg	Protected & compatible power generator (+/-15%)
										⊗ ELECTRONIC CONTROL	IA (60%)	X% (I2 max)			
AUTOPULSE 320-T1	400 V · 3~	5 m	16	0.6 → 1.2	15 → 320	-	OPTION	Air		ALU : Type B 1.0 / 1.2	260	320 A @ 35%	90x92,5x63 / 82.5	16 kVA	
AUTOPULSE 320-T1 208-240V	208 > 240 V · 3~	5 m	25	0.6 → 1.2	15 → 320	-	OPTION	Air		ALU : Type B 1.0 / 1.2	260	320 A @ 35%	90x92,5x63 / 82.5	16 kVA	
AUTOPULSE 320-T3	400 V · 3~	5 m	16	0.6 → 1.2	15 → 320	OPTION	OPTION	Air		ACIER : Type C 0.8 / 1.0 mm ALU : Type C 1.0 / 1.2	260	320 A @ 35%	75x40x94 / 82.5	16 kVA	
AUTOPULSE 320-T3 208-240V	208-240 V · 3~	5 m	25	0.6 → 1.2	15 → 320	-	OPTION	Air		ACIER : Type C 0.8 / 1.0 mm ALU : Type C 1.0 / 1.2	260	320 A @ 35%	75x40x94 / 82.5	16 kVA	

HELMETS TECHNOLOGY

	Intensity (A)														
	1.5	70	100	125	150	175	200	225	250	300	350	400	450	500	600
MAG	8	9	10			11				12				13	
MIG			9	10		11				12		13	14		
MIG light alloys				10	11	12				13		13			
PLASMA			9	10	11	13									

Teinte initiale - Initial shade



Classic **ULTRA CLEAR**

Spectre de couleur - Spectrum view

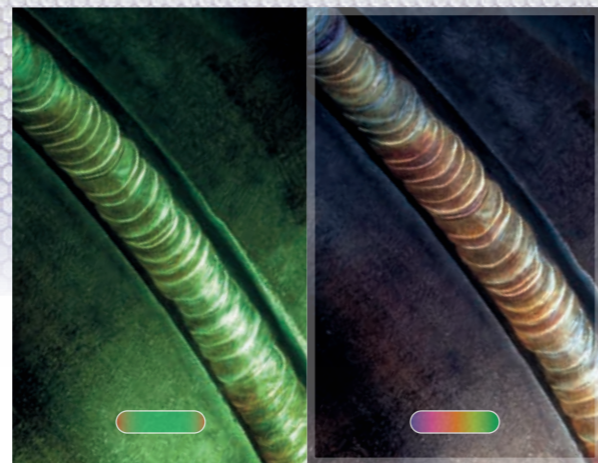

Classic **TRUECOLOR**

Capteurs sensibles - Sensitivity sensors



Classification - X=/X=/X=/X=

1/1/1/1 = PERFECT QUALITY

(1) Qualité optique (distorsion). (2) Diffusion de la lumière (contraste). (3) Variation de la transmission lumineuse (homogénéités de la teinte foncée). (4) Lumière angulaire (filtre de rayons lumineux diagonaux).

(1) Optical quality (distortion). (2) Light diffusion (contrast). (3) Variation of light transmission (homogeneities of the dark shade). (4) Angular light (diagonal light ray filter).

(1) / (2) / (3) / (4)

Serre-tête - Headgear



HELMETS 9-13



LCD FIREMAN 9-13 TRUECOLOR 062269

◀ 100 x 49 mm | ▶ 0.1 ms
GRIND TRUECOLOR



LCD GYSMATIC 9/13 G TRUECOLOR 043909

◀ 100 x 60 mm | ▶ 0.08 ms
GRIND + (10-11) x 4 TRUECOLOR



LCD GYSMATIC 9/13 G AIR TRUECOLOR 065727

Filtration class EN 12941 : TH2 P R SL
Air 165 / 200 / 220 L/min
Battery included
OPTION Filter TH3 065734

- Battery charger 037472 028869
- Battery included 037465
- 038424
- 038417

HELMETS 5-9/9-13



ZEUS 5-9/9-13 G INDIAN 038332

◀ 100 x 67 mm
▶ 0.1 ms
GRIND + (10-11) x 4 TRUECOLOR



ZEUS 5-9/9-13 G FIRE 044098



ZEUS 5-9/9-13 G COSMIC 044104

OPTIONS

- Sac pour masque de soudage - Carry bag for helmet welding 043299
- 066656
- Bandeau anti-transpiration - Antiperspirant - headband 043466 for Multifit+, Ergofit + Multi, Simple 062627 for Comfort Pro x2 070844 for Gysmatic 9/13 Air, Gysmatic 5/13 Air XXL
- Loupe - Magnifying glass for Zeus, Ergotech & Alien True Color x1 zoom x2 042780 zoom x3 064140

VERRES - Lenses - Schutzgläser	Dimensions	Part No.	Model	TRUECOLOR	HF	DELAY	Classification	Sensitivity	View	Weight	MASK BRAND
226 x 106 (x5)	103.6 x 54 (x5)	045781	LCD FIREMAN 9-13 TRUECOLOR	4-9>13	0.10 ms	0.15 > 0.8 s	1/1/1/2	2	100x49 mm	Multifit+	490 g Gys
114x133 (x10)	G: 106 x 66 (x10)	043893	LCD GYSMATIC 9/13 G TRUECOLOR	4-9>13	0.08 ms	0.10 > 0.90 s	1/1/1/2	4 HIGH SENSIBILITY	XL: 100x60 mm	Simple	580 g Gys
114 x 133 (x10)	103.7 x 69.5 (x5)	043695	ZEUS	4-5>9 / 9>13	0.10 ms	0.15 > 0.8 s	1/1/1/2	4	XL: 100x67 mm	Multi	520 g Gys

HELMETS

4-8/8-13



EXCLUSIVE FOR PROFESSIONAL



GYSMATIC FLIP-FLAP GOGGLE 3 TRUECOLOR
068711

GYSMATIC GOGGLE 3 TRUECOLOR
068704

◀ 130 x 58 mm | □→■ 0.05 ms



NEW
11 2021

◀ 130 x 58 mm | □→■ 0.1 ms



NEW
11 2021

ERGOFIT +

ULTRA CLEAR INITIAL SHADE 3

DIGITAL CONTROLS AUTOMATIC & MANUAL OPTIONS

WIDE VISION XL

ERGOFIT +

ULTRA CLEAR INITIAL SHADE 3

DIGITAL CONTROLS AUTOMATIC & MANUAL OPTIONS

180° XXL

PANORAMIC VIEW & WIDE VISION XXL

x7 HIGH SENSITIVITY SENSORS

TORCHES ASPIRANTES - Fume Extraction Torches

BINZEL

Acier/Inox - Steel/Stainless steel - Stahl/Edelstahl

AIR	150 A	250 A
original equipment	M6	M6
	Ø0.8	Ø1.0
X % 40°C - ArCO ₂	150A - 60%	200A - 60%
GRIP		GRIP
L	3m	3m
Ref.	043251	040540

ASPIRATEUR DE FUMÉE - Fume Extraction System

BINZEL

- 230V / 1 ~, 1100 W
- 200 m³/h max
- 190 mbar max
- 26 kg, 390 x 210 x 500 mm
- 71 db
- Système de nettoyage automatique du filtre - Filter auto cleaning system - Automatische Filterabreinigung

Automatic ON/OFF
043237
Manual
043244

100 m³/h

ASPIRATEURS DE FUMÉE - Fume Extraction Systems - Rauchgasabsauggerät

UNI 2.0 RE

- 400V / 3 ~ / 50 Hz
- 1100 W
- 1500 m³/h max
- 3-4h/day
- arm 3 m
- no plug
- 100 kg
- extraction 0.5 m/s

061545

Included
Pré-filtre (treillis aluminium) - Pre-filter (aluminium mesh) Class G3 EN 779

Filter - Filter Class H12 EN 779 Filtration > 99% 046467

Option
Flexible d'extraction 10 m Ø 150 mm 062139

EVO 2.1 RE

- 230V / 1 ~ / 50 Hz - 32A
- 1100 W
- 1200 m³/h max
- occasionnal
- arm 3 m
- included
- 85 kg

061552

Breveté - Patented

Included
Pré-filtre (treillis aluminium) - Pre-filter (aluminium mesh) Class G3 EN 779

Filter - Filter Class H12 EN 779 Filtration > 99% 046467

Option
Flexible d'extraction 10 m Ø 150 mm 062139

PROFI MASTER

- 1100 W
- 1100 m³/h
- 72 dB (A)
- arm 3m
- 104 Kg (with arm)
- 400V / 3 ~ / 50 Hz

067783

Pre-filter x1 067820

Main filter x1 067844

SMART MASTER

- 1100 W
- 950 m³/h
- 72 dB (A)
- occasionnal (1 sel N)
- arm 3m
- 81 kg (with arm)

• 230V / 1 ~ / 50 Hz
included 067769

• 115V / 1 ~ / 60 Hz
no plug 067776

Pre-filter x10 067790

Pre-filter x10 067806

Main filter x1 067813

VERRES - Lenses - Schutzgläser	TRUECOLOR	HF	DELAY	SENSITIVITY	ARM	WEIGHT	BRAND						
290 x 147.5 (x10) 071025	135.2 x 62.8 (x10) 071018	LCD GYSMATIC FLIP-FLAP GOGGLE 3	3 - 4 > 8 / 8 > 13	0.05 ms	—	0.06 > 1.0 s	1/1/1/1	3	XL : 138x58 mm	—	ERGOFIT +	578 g	Gys
385.8 x 137.7 (x10) 070998	133.5 x 60.4 (x10) 070981	LCD GYSMATIC GOGGLE 3	3 - 4 > 8 / 8 > 13	0.10 ms	✓	0.06 > 0.10 s	1/1/1/1	7 HIGH SENSITIVITY	XXL : 130x58 mm + 2x52x48 mm	—	ERGOFIT +	580 g	Gys



INDUCTION HEATING

CAR BODY

PFC POWER FACTOR CORRECTION

185 V ← 265 V

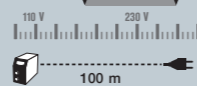

Youtube



055490

GYSDUCTION AUTO

2 400 W 230 V • 1 ~

PFC AIR



3 m

NEW



For use < 3600W

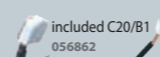

included C20/B1 056862

2 in 1

50LG



AUTO

INCLUDED COMBIDUCTION

Décapage Glass Entfernen 053373



Décollage Decal Entkleben 053359



OPTIONS

Inducteur spirale - Spiral inductor - Spiralinduktor 054783



1.2 kW



2.5 m

Débosselage sans peinture - PDR: Paintless Dent Repair - Lackschadenfreies Ausbeulen 054776

Licensed by BETAG innovation



3 m

Spray refroidisseur - Freezer spray

-50 °C 400 ml (x 12) 048898

Adhesive for logo (x10) 051492



1 box	PACKS - GYSDUCTION AUTO							
	PROLINER AUTO 048775	COMPLETE AUTO 053380	COMPLETE AUTO+ 056978	MECA AUTO 048812	MECA AUTO+ 056961	BODY SHOP AUTO 048799	GLASS AUTO 048805	DENT REPAIR AUTO 054981
GYSDUCTION AUTO	✓	✓	✓	✓	✓	✓	✓	✓
Plastic wedges 051294	✓	✓	✓	-	-	✓	✓	-
Burn off inductor 053373	✓	✓	✓	-	-	✓	✓	-
Body inductor 053359	✓	✓	✓	-	-	✓	-	-
Bolt inductor 053366	✓	✓	✓	✓	✓	-	-	-
Remote control 055490	✓	✓	✓	✓	✓	✓	-	-
Universal 800 051331	✓	-	-	-	-	-	-	-
Cable support 052284	✓	-	-	-	-	-	-	-
Dent pulling inductor 054776	-	-	-	-	-	✓	-	✓
Spiral inductor 054783	-	✓	-	-	✓	-	-	-

CONSUMABLES

for	for	for
Protection (x5) + Colle - Stick 053854	Protection (x1) + Colle - Stick 059108	Protection (x10) + Colle - Stick 053847

COMBIDUCTION AUTO 50LG

5 200 W 230 V • 1 ~

PFC LIQUID

065901

EN-60 335/1	MADE IN FRANCE	Cable L (m)	Freq. kHz	Tech. PFC	Liquid Cooling	Cable L (m)		Heating			cm	kg	Protected & compatible power generator (+/-15%)
						Inductor	Inductor	2 mm → 5 s	Ø8 → 10 s	36 x 27 x 22			
GYSDUCTION AUTO	230 V, 1~, 50/60 Hz	16 mini	2400	35+100	■	2	2.5	M10 → 1 s	2 mm → 5 s	Ø8 → 10 s	36 x 27 x 22	7.5	3 kW
COMBIDUCTION AUTO 50LG	230 V, 1~, 50/60 Hz	25 mini	5200	20+80	■ 71	8	3	M14 → 1 s	2 mm → 3 s 4 mm → 5 s	Ø10 → 10 s	59 x 88 x 59	72	6 kW



POWERDUCTION

INDUCTION HEATING

MAINTENANCE / MECHANIC / INDUSTRY

PFC POWER FACTOR CORRECTION

185V ↔ 265V

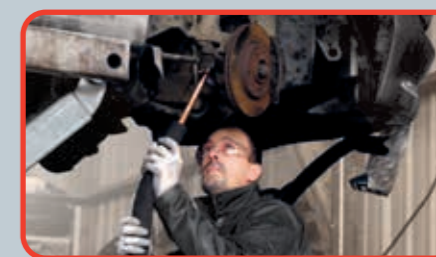

81

POWERDUCTION

INDUCTION HEATING

INCLUDED

Spirale - Coil - Spiralförmiger draht

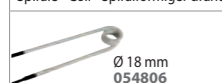

Ø 18 mm
054806



Ø 24 mm
054790



Ø 30 mm
055469

Fil tressé enroulable - Flexible wrappable wire - Flexibel geflochtener draht



800 mm
054813

Fil droit rigide - Straight rigid wire - Steif gerade draht

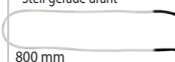

800 mm
054868



1 m

POWERDUCTION 10R

1 200 W 230V • 1~

AIR

062504

068643



2 m

POWERDUCTION 37LG

3 700 W 230V • 1~

LIQUID

056992

3 m



included C20/B1
056862

POWERDUCTION 39LG

3 700 W 230V • 1~

PFC LIQUID

058583



included
For use < 3600W

included C20/B1
056862

3 m



POWERDUCTION 50LG

5 200 W 230V • 1~

PFC LIQUID

055599

included adapter
32L + L90
064515 + 059788

4 m



POWERDUCTION 110LG

11 000 W 400V • 3~

LIQUID

058590

POWERDUCTION 110LG 208-240V

11 000 W 208-240V • 3~

LIQUID

065246

NEW

OPTION 10R

NEW

Decal - Décollage - Entkleben
066601



OPTION 37LG

Cable support
052284



Chariot - Trolley
UNIVERSAL 800
051331



Youtube

EN-60 335/1	MADE IN FRANCE	Cable L (m)	A	W	Freq. kHz	INTEGRATED TECHNOLOGY		Liquid Cooling	Cable L (m)		Heating		cm	kg	Protected & compatible power generator (+/-15%)	
						P400	PFC		Inductor	Heating	Heating					
POWERDUCTION 10R		230V, 1~, 50/60 Hz	10 mini	1 200	45+80	—	—	—	2	1	M10 → 1s	2 mm → 5 s	Ø8 → 10 s	23 x 14 x 10	3	1.5 kW
POWERDUCTION 37LG		230V, 1~, 50/60 Hz	16 mini	3 700	15+30	—	—	1.5l	2	2	M10 → 1s	2 mm → 5 s	Ø10 → 15 s	45 x 29 x 25	15	4 kW
POWERDUCTION 39LG		230V, 1~, 50/60 Hz	16 mini	3 700	20+60	■	■	7l	2	3	M12 → 1s	2 mm → 5 s	Ø10 → 15 s	53 x 70 x 37	39.5	4 kW
POWERDUCTION 50LG		230V, 1~, 50/60 Hz	25 mini	5 200	20+60	■	■	7l	8	3	M14 → 1s	2 mm → 3 s 4 mm → 5 s	Ø10 → 10 s	59 x 88 x 59	70	6 kW
POWERDUCTION 110LG 400V		400V, 3~, 50/60 Hz	16 mini	11 000	20+60	—	—	7l	5	4	M18 → 1s	2 mm → 2 s 4 mm → 4 s	Ø10 → 7 s	59 x 88 x 59	80	15 kW
POWERDUCTION 110LG 208-240V		208-240V, 3~, 50/60 Hz	35 mini	11 000	20+60	—	—	7l	5	4	M18 → 1s	2 mm → 2 s 4 mm → 4 s	Ø10 → 7 s	59 x 88 x 59	86	15 kW



POWERDUCTION - ACCESSORIES & CONSUMABLES



POWERDUCTION 160LG

POWERDUCTION 160LG 208-240 V

POWERDUCTION 220LG

16 000 W 400 V • 3~

16 000 W 208-240 V • 3~

22 000 W 400 V • 3~

* LIQUID

* LIQUID

* LIQUID

057814

065253

066861

CE NORM. EN-60 335/1	MADE IN FRANCE	Cable L (m)	Freq.	Liquid Cooling	Inductor		Heating		cm	kg	Protected & compatible power generator (+/-15%)		
					A	W	kHz	Inductor				Heating	
POWERDUCTION 160LG 400V	400V, 3~ 50/60 Hz	32 mini	16 000	20+60	301	4	6	M20 → 1s	2 mm → 2s 4 mm → 4s	Ø10 → 5s	70 x 118 x 60	120	22 kW
POWERDUCTION 160LG 208-240V	208-240V, 3~ 50/60 Hz	45 mini	16 000	20+60	301	4	6	M20 → 1s	2 mm → 2s 4 mm → 4s	Ø10 → 5s	70 x 118 x 60	130	22 kW
POWERDUCTION 220LG	400V, 3~ 50/60 Hz	32 mini	22 000	20+60	301	4	6	M45 → 3s	8 mm → 9s 4 mm → 3s	Ø10 → 4s	70 x 118 x 60	125	22 kW

OPTIONS

NEW

Poignée de lance - Removable handle - Abnehmbarer Griff for POWERDUCTION 160 - 220 LG 068599

Housse de protection - Protection cover - Schutzhaube for POWERDUCTION 160 - 220 LG 050853

Cooling liquid (not included)

5L 062511
10L 052246

t° POWER HEAT CONTROLLER

t° CONTROL
80>350°C (210>660°F)

NEW

5,5m

POWER HEAT CONTROLLER
061644

Included T° sensors thermocouple type K x2

QR code and Youtube link.

OPTIONS

Pyrometer IR for inductor L90

1.1 m 064119

INDUCTEURS - Inductors

	SMALL (Ø16)										LARGE (Ø32)																		
	NEW										NEW																		
	S90	S70	S180	S20/B1 (20°)	S180/B1	S180/B2	S180/B3W	S180/D20	S180/D25	S180/D30	S180/D35	S180/D40	S180/D45	S180/D50	S180/D55	L90 (90°)	L70 (70°)	L180	L180/Spiral	L20/B4	L20 Alu Glove	L180/D60	L180/D70	L180/D80	L180/D90	L180/D100	L180/D110	L180/D120	
* = original equipment	058927	061569	059269	064874	064881	064928	067899	069985	069992	070592	070608	070615	070622	070639	070646	059788	059771	059795	065000	067882	069114	069923	069930	069121	069947	069954	069961	069978	
37 LG	✓*			✓																									
39 & 50 LG																													
110 & 160 LG																✓ with adapter 32L*													
220 LG																													

	ADAPTER			
	285 M28 Ø16 064485	325 M32 Ø16 064508	28L M28 Ø32 064492	32L M32 Ø32 064515
37 LG				
39 & 50 LG	✓			
110 & 160 LG			✓	✓
220 LG			✓	✓

	COMPLETE (Ø28)		
	C20/B1 (20°) 056862	C180/B1 (90°) 056879	C180/B2 (90°) 056886
39 & 50 LG	✓*		✓

BOÎTES - Boxes

285/B for 39LG & 50LG 065802

325/B for 110LG & 160LG 065819

L box 065796

included: S20/B1 (x1), S180/B1 (x1), S180/B2 (x1), 285 (x1), B1 (x1), B2 (x1)

included: S20/B1 (x1), S180/B1 (x1), S180/B2 (x1), 325 (x1), B1 (x1), B2 (x1)

included: L70 (x1), L180 (x1)

FERRITES - Ferrites - Ferritaufsatz

B1 053823

B2 053458

B3 067875

B4 053755

B1 056909

B2 056916

Cloche accostage 069701

B4 054844

Colle-Stick bi-composants Power Epoxy 150°C 054851

COFFRET DE DÉCOUPE PARE-BRISE - Professional Box Set for Windscreen Removal
- Frontscheiben-Trennsystem für Akkuschrauberbetrieb

MADE IN HIGH QUALITY GERMANY



057654

included
Axe enrouleur
068100

included
65 m
resistance 170 kg
Ø 0.79 mm
058125

optional
65 m
resistance 190 kg
Ø 0.92 mm
069275

NEW



COUTEAU PNEUMATIQUE DE DÉCOUPE PARE-BRISE
- Oscillating Pneumatic Saw for Windscreen Removal
- Druckluft-Trennmesser für Windschutzscheiben

057623



Included
57 mm
057845

90 mm
057852

8 mm
057876

35 mm
057838

U
36 mm
057869

EXTRACTEUR D'ESSUIE-GLACE - Removal tool for windscreen wiper arms - Wischerarm-Abzieher

UNIVERSEL
057630



EXPERT

Accès difficile
- Difficult access
057647

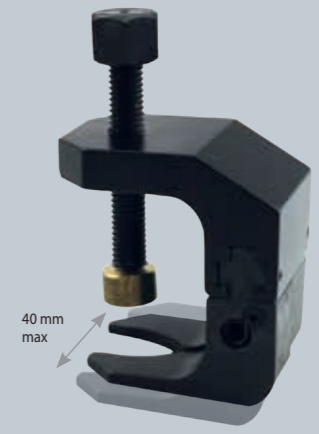

SYSTÈME DE DÉCOUPE PARE-BRISE À CLIQUET
- Windshield Cutting kit - Set zum Lösen von Windschutzscheiben

054738

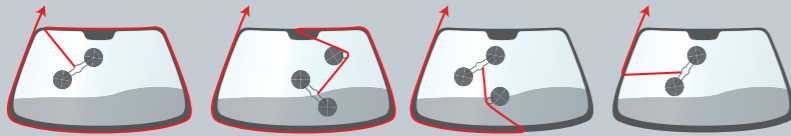

PROTECTIONS TABLEAU DE BORD
- Dashboard Protector - Armaturenbrett Schutz

053120

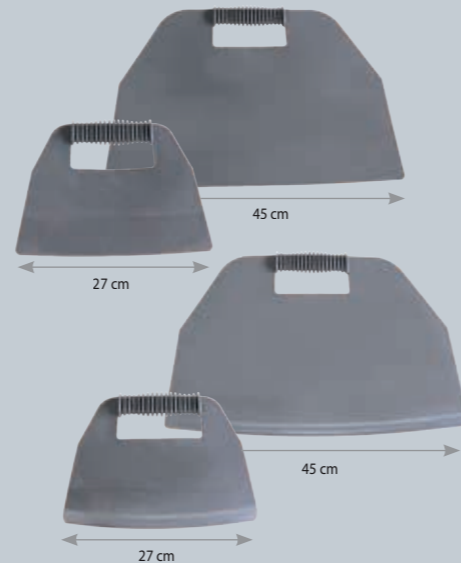

VENTOUSES - Suction Lifting Pads - Saugnapfwerkzeug für Spiegelgläser

056695



051966



x6
057609

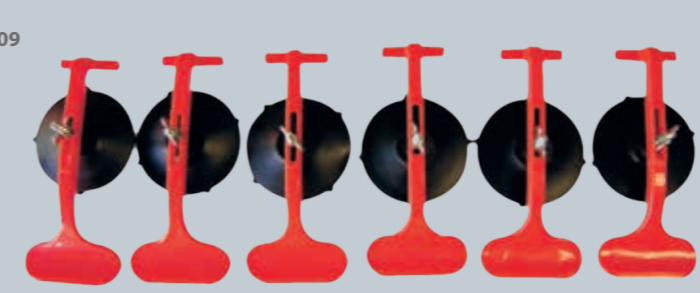

OUTIL DÉCOUPE PARE-BRISE
- Windshield Cutting Tool - Windschutzscheiben Demontage-Set

051935

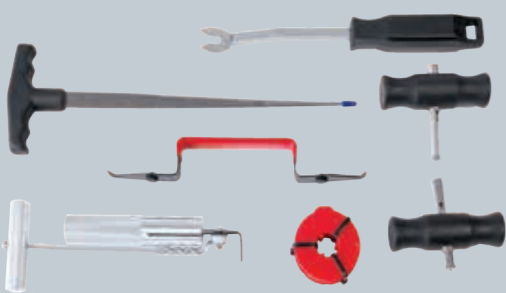

KIT DÉCOUPE JOINT DE PARE-BRISE - Windscreen Joint-cutting Kit - Scheibentrenn-Werkzeug-Set

051898



Corde à piano torsadé (22 m)
- Windscreen seal cutting wire (twisted)
- Piano-Schneiddraht, gedreht, 22 m Rolle

051911

Corde à piano carré (50m)
- Windscreen seal cutting wire (square)
- Vierkant-Draht, 50 m Rolle

051881

RENOV'POLYCARBONATE - Compressed air polisher - Druckluftpolierer

Complete pack

1 ponceuse orbitale
+ 1 lustreuse
- 1 orbital sander
+ 1 polisher

052086



2 SPEED

+

+

+

052055

052062

052079

+

+

sander Ø75

057494

polisher Ø75
058224

Ø 76

P 500 (x 10)
P 800 (x 10)
P 1500 (x 10)
P 3000 (x 10)



P 500 x 50 052017
P 800 x 50 052024
P 1500 x 50 052031
P 3000 x 50 052048

AGRAFEUSE POUR RÉPARATION PARE-CHOCS - Hot stapler for bumper repair - Stoßstangen Reparatur Kit

052925



INCLUDED:
x20 x20 x20 x20 x20

MADE IN TAIWAN

PORTABLE
Sur batterie - Battery operated
058118

included
Li-ion battery 3.7 V
048669
included adapters:
EUR, UK, USA & AUS

Charger included
048652

MADE IN TAIWAN



INCLUDED:
Ø 0.6, x100 Ø 0.8, x100
Ø 0.6, x100

Agrafes - staples

Angle interne étroit - Inside corner Ø 0.7 mm	Alignement de fissure - Crack alignment Ø 0.7 mm	Fissure importante - Large crack Ø 0.7 mm	Angle interne - Internal angle Ø 0.7 mm	Angle externe - External angle Ø 0.7 mm
x 100 047990	x 100 047983	x 100 047976	x 100 047969	x 100 047952
052413				
=	+	+	+	+
x 50	x 50	x 50	x 50	x 50

COFFRET DE PERÇAGE PARE-CHOCS POUR DÉTECTEURS - Piercing Kit for Bumper Sensors - Lochwerkzeug für Stoßfänger



PRO+
059139

Ø 17-18-18,2
19-20-22,5-24
26-26,7-32 mm



FREEZER

Spray refroidisseur
- Freezer spray

-50 °C

400 ml

(x 12)

048898



COFFRET DE RÉPARATION DES PLASTIQUES AUTOMOBILES - Brazing automotive plastics repair kit - Kunststoff Reparatur Set



052932

MADE IN BELGIUM



x10
052956

25 x 12.5 cm
x2
052949

057258

052963

STATION DE SOUDAGE DES PLASTIQUES - Plastic welding station - Kunststoff-Schweißset



OPTION



Trolley SPOT 600
053533

320 W - 230 V, 1-50 Hz
Temperature : 160 < 480°C
▲ 3.4 kg
Length of hose : 1 m
Air flow : 24 l/min

Station seule
- Station only
064072



Ø 5 mm
066694

Ø 8 mm
066700

baguettes plastique 440 mm	PP / EPDM	▲ 4 mm	x 10	066304
		■ 6 mm	x 10	067622
	ABS	▲ 4 mm	x 10	066298
		■ 8 mm	x 10	071322
		▲ 4 mm	x 10	071322
		■ 8 mm	x 10	071339

	Station	PP/EPDM			Pressure wheels	Mini milling machine	Scraper
		▲ 4mm (x10)	■ 6mm (x10)	■ 8mm (x10)			
064072	✓						
062726			✓				
070974				✓			



Grattoir - Scraper
068032

Roulette de compression
- Pressure wheels
058231

Mini fraiseuse -
Mini milling machine
063228

Tungsten drill Ø 5 mm
included
063235

KIT DE SOUDAGE DES PLASTIQUES - Welding Kit for Plastics - Kunststoff-Schweißset

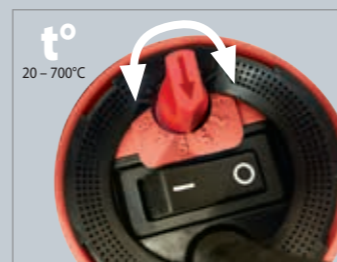

t°
20 - 700°C

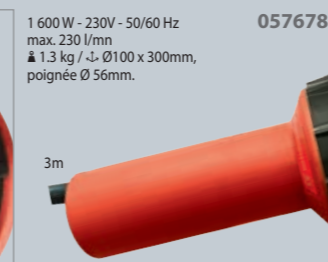

1 600 W - 230V - 50/60 Hz
max. 230 l/min
▲ 1.3 kg / -L Ø100 x 300mm,
poignée Ø 56mm.

057678



Options

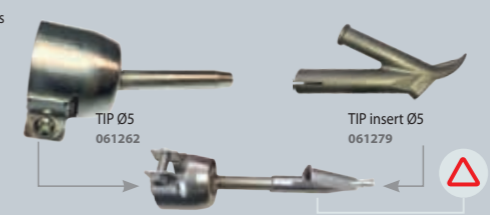

TIP Ø5
061262

TIP insert Ø5
061279



20mm

x10
052956

x1
25 x 12.5 cm
052949

GYS HAND TOOLS - Ausbeulwerkzeug

• **FULL PACK =**
061637

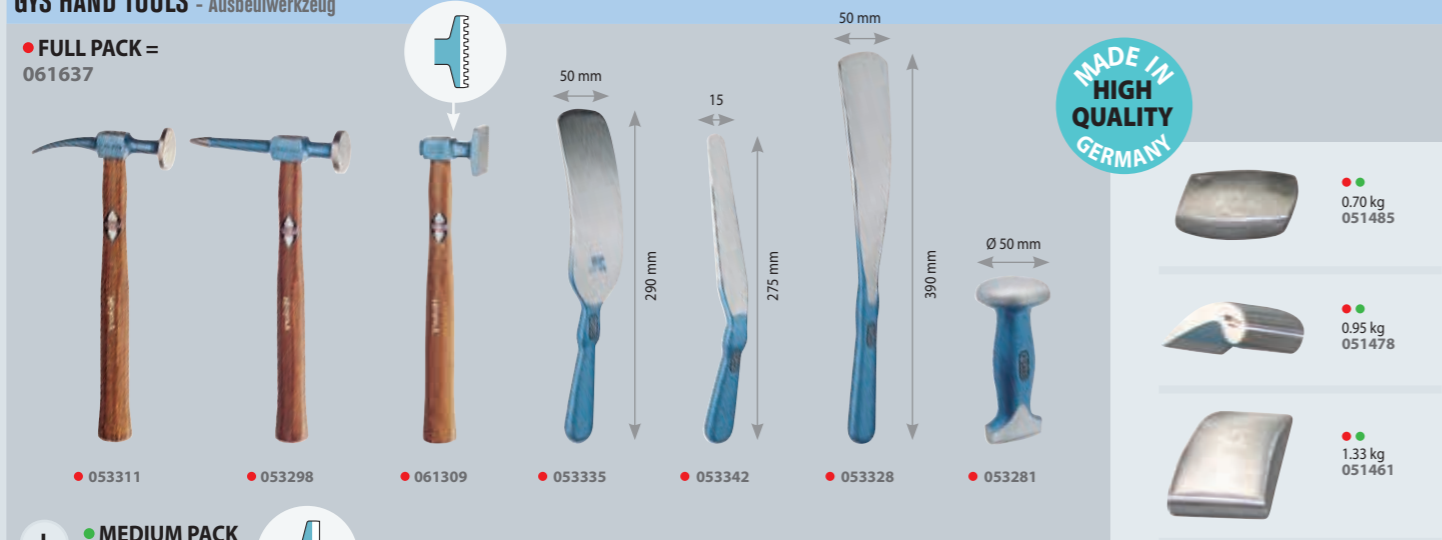

+ **MEDIUM PACK**
051133



KIT MARTEAUX ET TAS - Planishing Kit for Car Body (Set of 3 Hammers + 4 Dollies) - Karosseriehammer & Handfaust Kit



OUTILS DE FORME - Forming tools - Formgebungswerkzeuge



OUTILS DE DÉGARNISSAGE ET RACLAGE - Set of 30 Tools for scraping/sanding and paint removal - Polster & Schaber Kit



BURINS - Hand Chisel for Car Body - Meißel für Karosserie

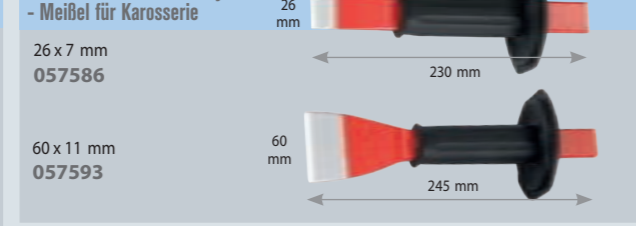

JEU DE 4 BURINS EN NYLON - Set of 4 nylon chisels - 4 Kunststoffmeißel

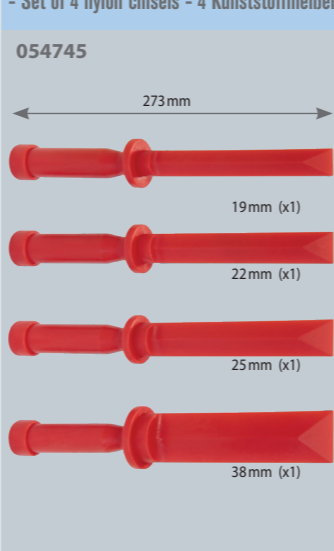

COUTEAUX RACLOIRS



JAUGES DE PROFIL - Contour Gauge - Konturenlehre

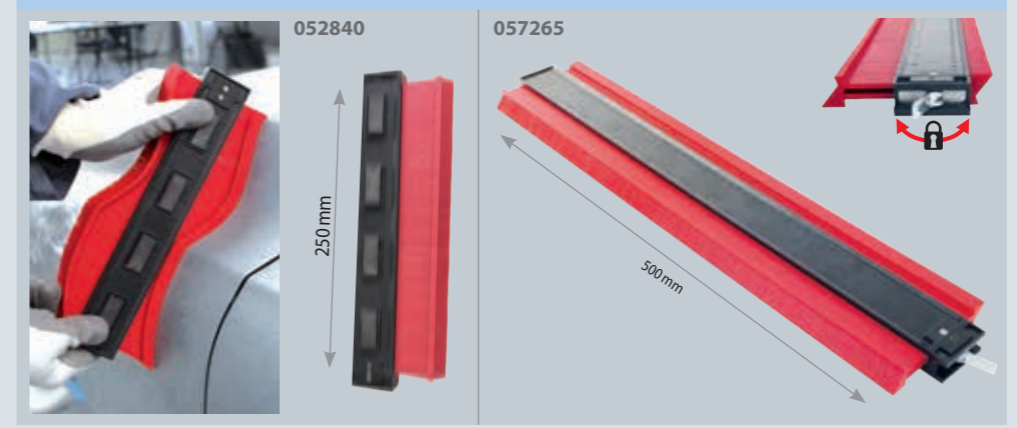

JAUGES DE POSITIONNEMENT - Gapping gauges - Spaltmaßlehre



OUTIL DE REMISE EN FORME PASSAGE DE ROUE - Fender roller tool set

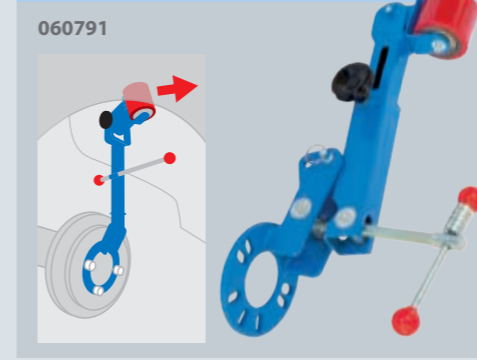

REDRESSEUR DE CHARNIÈRE DE PORTE - Fixed Hinge Bending Tool



PINÇES DE MAINTIEN BORD À BORD - Positioning clamp - I-Stoß-Lehre

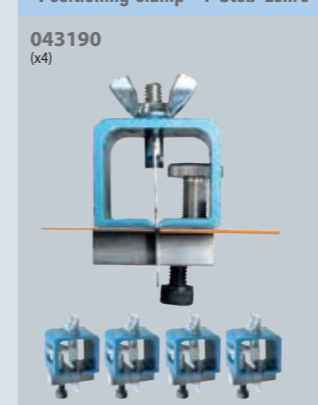

PINÇES MICRO-GRIP - Micro-grip clamps

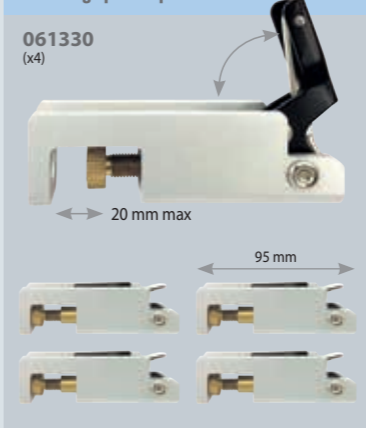

PINÇES ÉTAU À BEC PLAT - Flat nose lock-grip pliers

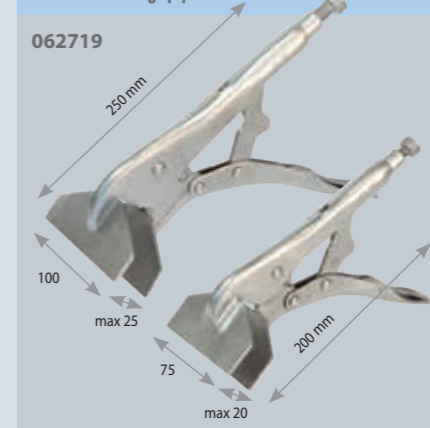

SERRE-TÔLES - Temporary-fasteners manual mounting

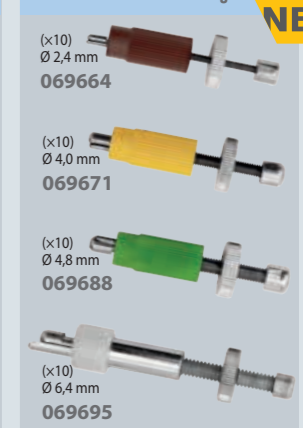

PINÇES AXIALES - Axial-grip pliers

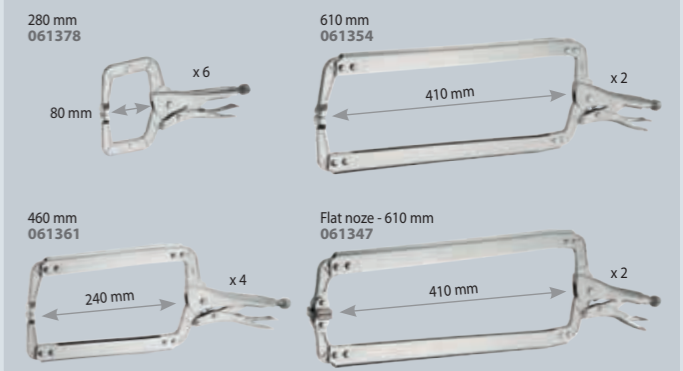
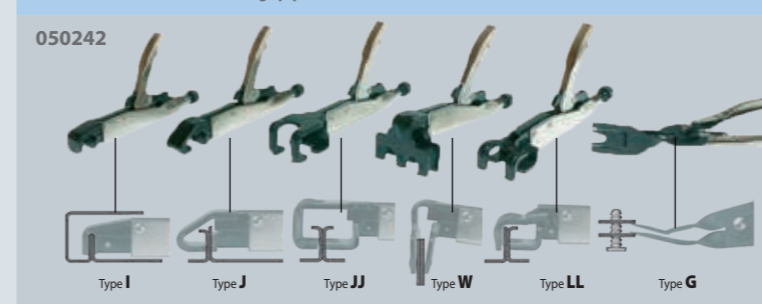

PINÇES ÉTAU MONO SERRAGE - Lock-grip pliers

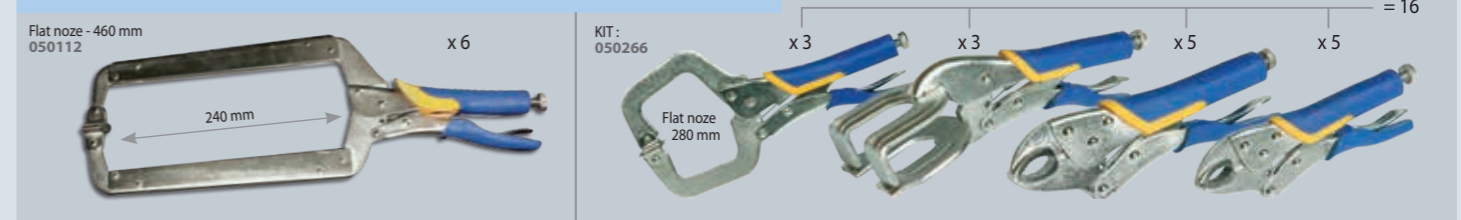

MINI-MEULEUSE - Mini disc sander - Druckluftschleifer

051829

Speed adjustment

Ø 75 mm

Speed rpm	Power W	dB	Air consumption l/min	Air pressure bar	cm	kg
18000	200	83	171	6.2	12	0.7

Included (x1) 052468

MEULEUSE D'ANGLE - Long Handled Angle Grinder - Druckluft-Winkelschleifer

057753

Ø 100 mm

± 1.6 mm, x5 057883

± 0.8 mm, x5 058217

Speed rpm	Power W	dB	Air consumption l/min	Air pressure bar	cm	kg
14000	84	113	6.2	37	1.7	

058248

MINI-FLEXIDISC LAMELLES ZIRCON Ø 50 mm

K 40 (x10) 058255

K 60 (x10) 058262

K 80 (x10) 058279

x2 Ø

Ø 50 & 75 mm

Speed rpm	Power W	dB	Air consumption l/min	Air pressure bar	cm	kg
15000	84	91	6.2	10	0.6	

MINI-MEULEUSE À RENVOI D'ANGLE - Mini Angle Grinder - Mini-Druckluftwinkelschleifer geräuschgedämpft

051867

Ø 50 mm

90°

Speed rpm	Power W	dB	Air consumption l/min	Air pressure bar	cm	kg
15000	200	86	85	6.2	18	0.75

(x1) 052772

PONCEUSE À BANDE À TÊTE ORIENTABLE - Air belt sander - Druckluft Bandschleifer

060906

520 mm

20 mm

360°

Grain 60 (x 5) 060913

Grain 80 (x 5) 060920

Grain 100 (x 5) 060937

Grain 36 céramique (x 5) 062535

Speed rpm	Air consumption l/min	Air pressure bar	cm	kg
16 000	171	6.3	34	1.2

SCIE COUPE TÔLE DROITE ET LIME - Saw for Straight Cut and File - Druckluftsäge und Feile

051805

(x5) 052789

included 058750

Speed rpm	Power W	dB	Air consumption l/min	Air pressure bar	cm	kg
5000	—	85	255	6.2	10	0.8

PONCEUSE À BANDE À TÊTE ORIENTABLE - Air belt sander - Druckluft Bandschleifer

052819

360°

330 mm

10 mm

Grain 80 (x 10) 052833

Grain 36 céramique (x 20) 062528

Speed rpm	Air consumption l/min	Air pressure bar	cm	kg
16000	171	6.3	26	0.9

MINI-FRAISEUSE À RENVOI D'ANGLE - Mini Angle Milling Machine - Mini-Winkelschleifer

051836

90°

Speed rpm	Power W	dB	Air consumption l/min	Air pressure bar	cm	kg
18000	500	81	85	6.2	18	0.7

PERCEUSE MANDRIN AUTOMATIQUE - Automatic Mandrel Drill - Druckluftbohrmaschine m. Schnellspannfutter

051799

Ø 13

Speed rpm	Power W	dB	Air consumption l/min	Air pressure bar	cm	kg
800	300	92	170	6.2	18	0.9

COFFRET DÉCAPEUSE PNEUMATIQUE - Pneumatic surface remover Kit - Druckluftentroster-Box inkl. Zubehör

051775

Roue gomme 115 x 14 mm 051874

Roue à découper 115 x 14 mm 051843

Adaptateur pour brosse 051768

Brosse souple Brins droits 0.5 mm 103 x 23 mm 052598

Brosse dure Brins incurvés 0.7 mm 103 x 23 mm 051812

Brosse souple Brins incurvés 0.5 mm 103 x 23 mm 051850

Speed rpm	Power W	dB	Air consumption l/min	Air pressure bar	cm	kg
4000	500	86	102	6.2	280	1.2

PINCE À SOYER ET À TROUER, Ø5MM PNEUMATIQUE - Pneumatic flange / ø5 mm punching tool - Pneumatische Loch- und Absatzzange Ø 5 mm

052543

2 in 1

Ø 5 mm

0.8 > 1.2 mm

0.8 > 1.2 mm

MINI FRAISEUSE - Mini milling machine - Mini-Schleifer

063228

Option Tungsten drill Ø 6 mm 054172

OUTIL DE POINÇONNAGE OBLONGS - Punching tool for oval holes - Langlochkarosserieblechzange

2.2 kg

6 mm 20 mm 052437

8 mm 20 mm 067264

BODY ZIPPER - Sertisseuse pneumatique Pneumatic Crimper - Druckluftkantenformer

056930

MADE IN HIGH QUALITY POLAND

1) MINI

2) initial W

3) final M x < 2.4mm

4) final D x > 2.4mm

Air pressure bar 5

cm 28

kg 2.1

DÉPOINTEUSE POUR CORDON LASER ACIER - Laser cord metal sheet cutter (nibbler) - Trennwerkzeug für Lasernähte

054165

Ø 6 mm

STEEL Included 054172

DÉPOINTEUSE - Spot remover - Druckluft-Schweißpunktbohrer

SPOT DRILL 050464

360°

Ø 8

Included: Tungsten Carbide Ø 8 for BORON/UHSS (x1)

Forets de dépointage - Spot remover drill - Schweißpunktfräse Tungsten Carbide for BORON/UHSS

3-edge	Ø 8 mm	Ø 9 mm	Ø 10 mm
053069	069763	053076	
4-edge Efficiency ++ Durability ++	Ø 8 mm	Ø 9 mm	
059849	069770		

Speed rpm	Power W	dB	Air consumption l/min	Air pressure bar	cm	kg
800	400	85	140	6.5	35	2.3

PACK SPOT DRILL + 140 mm 061460

140 mm 061453

3-edge Ø 8 mm 053069

140 mm

QR code and Youtube link

TOURNEVIS SANS FIL - Cordless Mini Screwdriver - Akkuschauber**DÉTECTEUR ÉPAISSEUR DE PEINTURE - Film coating thickness gauge**

Measurement range : 0 - 1.80mm
Resolution : 0.01 mm / 1 mm
Measurement error : +/- 0.03 mm
Power Supply : 2x 1.5V AAA batteries (included)
Overall dimensions : 62 x 30.5 x 105 mm

059856

**TOURNEVIS À CHOCS SANS FIL - Cordless Impact Screwdriver - Akkuschauber****PONÇEUSE /POLISSEUSE ÉLECTRIQUE - Electric Sander & Polisher - Elektro-Polier-Schleifer**

057999

Orbital 5.0 mm
↳ 303 x 101 mm
1.21 kg
Speed : 4000, 7000, 9000 10000 rpm
AC-in 220V - 230V / 50 - 60Hz

Light weight
& Compact

**ASPIRATEUR PNEUMATIQUE POUR POUSSIÈRES ALU (ATEX) - Pneumatic aluminium dust atex vacuum cleaner**

058866

Dust container capacity : 25 l
Working compressed air pressure : 7 bar
Compressed air consumption at 6 bar : 800 l/min
Suction connection diameter size : 50 mm
Max suction capacity : 150 m³/h
Max vacuum level : 2000 mm H₂O
Recommended compressor power : 7.5 HP

↳ 74 x 45 x 45 mm
■ 18 kg

**GYSDUST EXTRACTOR - Pneumatic dust vacuum cleaner for sander**

Aspirateur (sans ponçuse)
Vacuum cleaner (without sander)
071353
↳ 350 x 800 x 400
■ 21 kg

Ponçuse - Sander
Ø 150 mm
071346



- ✓ **ROBUST**
- ✓ **QUICK & SAFE**
- ✓ **LOW AIR CONSUMPTION**
(5 bar)
- ✓ **NO ELECTRIC MOTOR**
- ✓ **ENERGY SAVING**

INNOVATIVE SUCTION SYSTEM
Depression 1150 mm H₂O
Air flow 600 l/min
Air consumption 340 l/min

Ex ATEX norm
Group II - Category 3



Grande maniabilité et stabilité
- High maneuverability and stability



Consumables

Sac à poussières - Filter bag
Capacity 5 kg
Included x1
x5
058880

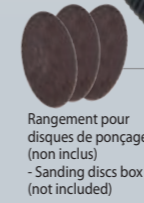

NEW
10 / 2021



PROJECTEURS LED SUR TRÉPIED - LED worklights with tripod - LED-Arbeitsleuchte mit Standfuß

Lampe sur TRÉPIED 1800 L
1800 lumens
 3x 55 COB LED total 165 LED
 1.8 m power cord
 059146

adjustable 1.3 m max

Lampe sur TRÉPIED 3000 L
3000 lumens
 35 W COB LED
 2 m power cord
 IP 44
 059979

adjustable 1.5 m max

Lampe sur TRÉPIED 4000 L
4000 lumens
 3x 20 COB LED, total 60 LED
 3 m power cord
 059986

adjustable 2.3 m max

2.3 m max

CONTRÔLE DES COULEURS - Detailing & colour match - Fabnpassung & Aufbereitung

100%	98	97	94	99	97	95	98	99	99	92	98	98	96	98	
	R1	R2	R3	R4	R5	R6	R7	R8	R9	R10	R11	R12	R13	R14	R15
	CRI														
	CRI +														

4500 K
400 lumens
SUNCOLOR 1
 COB LED, CRI > 95, 1100 lux
 3.7 V - 2600 mAh Li-ion
 USB charging
operating time : 3 h
 ↓ 190 x 56 x 29 mm
 290 g
 IP 65
 058477

3 COLORS
2700 - 4500 - 6500 K
350-420-450 lumens
SUNCOLOR 3
 COB LED, 96 CRI+
 3.7 V - 2600 mAh Li-ion
 micro USB charging (4 h)
operating time : 2.5/4 h
 IP 65
 ↓ 190 x 56 x 29 mm, 290 g
 060838

5 COLORS
2700 - 3500 - 4500 - 5500 - 6500 K
500-1000-2000 lumens
SUNCOLOR 5
 COB LED, 96 CRI+
 11.1 V - 4400 mAh Li-ion
 charger 110/240 V, 5 m cable, 15 V, 1.5 A
 charging time : 3.5 h
operating time
 High position : 2 h, Mid : 4 h, Low : 8 h
 IP 65
 ↓ 225 x 200 x 70 mm, 1.2 kg
 060876

5 COLORS
2500-3500-4500-5500-6500 K
250-500 lumens
SUNMATCH 3
 COB LED, 96 CRI+, 700-1400 lux
 3.7 V - 2600 mAh Li-ion, USB charging
operating time :
 High position : 2 h, Low position : 4 h
 IP 65
 ↓ 204 x 89 x 81 mm, 270 g
 061651

SCANGRIP COLOUR MATCH

SÉCHAGE UV - UV CURING
UV LED λ 395-400 nm
Irradiance 6-15 mW/cm²
NOVA-UV S
 3.7 V - 5400 mAh Li-ion
 USB charger, 1 m cable, 5 V, 2 A
 charging time : 3.5 h
 curing area : Ø 20 cm
operating time 1.5 h
 IP 67
 ↓ 163 x 63 x 163 mm
 061620

Curing area Ø 20 cm

SCANGRIP

LAMPES SOUS CAPOT - Under bonnet lamps - Leuchte für Motorhaube

Lampe SOUS CAPOT 600 L
500-1000 lumens
 120 COB LED
 3.7 V - 4000 mAh Li-ion
 charging time : 10/12 h
 1.7 kg
 059962

130 > 180 cm

AUTOBLOCK CLIP CLIP

Lampe SOUS CAPOT 800 L
250-800 lumens
 120 COB LED
 3.7 V - 4000 mAh Li-ion
 charging time : 10/12 h
operating time
 High position : 3 h
 Low position : 6 h
 058002
 058316

130 cm

LAMPES BALADEUSES - Hand lamps - Handleuchte

Lampe BALADEUSE TRIPODE 250 L
100-250 lumens (x3)
 3 x 1 W COB LED
 3 x 3.6 V - 300 mAh
 AAA rechargeable, Ni-MH
 USB charging (6h)
operating time
 High position : 1 h
 Low position : 3 h
 Flashing : 5 h
 ↓ 260 x 100 x 100 mm
 059955

Lampe BALADEUSE 400 L
400 lumens
 COB LED
 Li-ion
 Charging time : 8h
operating time
 High position : 2.5 h
 Low position : 5 h
 Top light (1 W) : 6 h
 ↓ 230 x 65 x 40 mm
 059153

Lampe BALADEUSE ÉTANCHE 400 L
200-400 lumens
 COB LED
 3.7 V - 2000 mAh Li-ion
 USB charging (4/6 h)
 mains charger not included
operating time
 High position : 2 h
 Mid position : 4 h
 Top light (4 W) : 3 h
 ↓ 285 x 65 x 65 mm
 IP 56
 059948

Étanche - Waterproof

Lampe BALADEUSE PRO 600 L
250-600 lumens
 COB LED, 80 CRI
 3.7 V - 2200 mAh Li-ion
 micro USB charging (3.5 h)
operating time :
 High position : 1.5 h,
 Mid position : 4.5 h,
 Top light (100 lumens) : 10 h
 ↓ 190 x 56 x 29 mm
 IP 54
 210 g
 060883

Lampe AMBIANCE 360° PORTABLE 1000 L
60-1000 lumens
 >80 CRI SMD LED
 6500 K
 3.7 V - 5200 mAh Li-ion
 USB charging (4.5h)
 USB power supply
operating time 2 > 27 h
 ↓ 260 x 75 x 75 mm
 IP 54
 450 g
 059764

360°

180°

USB charging /Power supply

Ambient light

LAMPES D'INSPECTION - Inspection lamps - Inspektionslampen

Lampe INSPECTION FRONTALE 280 L
100-280 lumens
 3 W COB LED, 80 CRI+, 6500 K
 3.7 V - 1500 mAh Li-po
 micro USB charging
 mains charger not incl.
operating time
 High position : 2 h
 Low position : 6 h
 IP 65
 110 g
 ↓ 78.5 x 47.5 x 42 mm
 060845

60°

motion detection mode

Lampe INSPECTION MINI 200 L
120-200 lumens
 COB LED, 80 CRI, 6500 K
 3.7 V - 700 mAh Li-ion
 micro USB charging (2.5 h)
 mains charger not included
operating time
 High position : 1.5 h
 Low position : 4 h
 Top light : 3.5 h
 IP 20
 76 g, ↓ 174 x 27.5 x 28 mm
 060852

360°

Lampe INSPECTION FLEXIBLE 500 L
50-500 lumens
 COB LED
 80 CRI+
 6500 K
 3.7 V - 2600 mAh Li-ion
 USB charging (4 h)
operating time
 High position : 2 h
 Low position : 16 h
 Top light : 9.5 h
 IP 54
 290 g
 ↓ 423 x 65.5 x 44.5 mm
 060869

FLEXIBLE

Lampe INSPECTION PRO 600 L
0-600 lumens
 COB LED
 6500 K
 3.7 V - 2600 mAh Li-ion
operating time
 1.5 > 15 h
 ↓ 380 x 40 x 45 mm
 300 g
 057760
 058309

180°

charge indicator

120 lumens

360°



TRÉTEAUX - Frames support - Klappböcke

040601
100.5 x 112 cm - 5.5 kg
35 x 95 x 106 cm
Ø28mm
4 pieds coudés
Idéal sur callebottis
- Bent feet for grating
- Abgewinkelte Standfüße:
- Sicherer Stand auf Gittern u.ä.

040250
100 x 105 cm - 7kg
32 x 10 x 106 cm
Ø32mm
Chaine réglable
- Adjustable catenary

040311
104.5 x 117 cm - 8.1kg
32 x 10 x 106 cm
Ø32mm
4 ventouses
Dépose vitrages
- Suction pad for glazing
- Gummiteller zur Fixierung
- von Glasscheiben

040304
104.5 x 108.8 cm - 8.1kg
32 x 10 x 106 cm
Ø32mm
Mousse de protection
- Protecting foam

Léger et très maniable
Spécial travaux à l'horizontal
- Light and easy to handle
- Ideal for horizontal works
- Speziell geeignet für Arbeiten
- in horizontaler Position

Antidérapants
- Non-slip base

NEW

070677
20 x 20 mm
16.5 kg
15 > 125 cm
88 > 128 cm
3 mm
87 cm
MADE IN HIGH QUALITY POLAND

059818
86 x 67 x 13 cm
25 x 25 mm
24 kg
18.5 > 132 cm
81 > 133 cm
6 mm
86 cm
MADE IN HIGH QUALITY POLAND

**SUPPORT PARE-CHOCS - Rotary element support
Lackierstander für Stoßstange, einstellbar**

052376
91 x 105 cm - 7.6 kg
60 x 11 x 75 cm

Adapté aux coques de rétroviseurs
- Adapted to wing mirror covers
- Geeignet für Außenspiegel

059825

50 cm

106 x 104 x 215 cm - 32.5 kg
112 x 31.5 x 21.5 cm
+ 12 x 9.5 x 194.5 cm

059832

50 cm

50 x 150 cm - 13 kg
152 x 15.5 x 11.5 cm

**SUPPORT ÉLÉMENT ROTATIF - Rotary element support -
Lackierstander für Stoßstange, einstellbar**

052611
200 x 101 cm - 17.5 kg
35 x 15 x 110 cm
Made in China

PRO 056725
200 x 105 x 81 cm - 22 kg
24 x 17 x 118 cm

1.5 mm
360°
2 mm
Verrouillage de l'axe - Locking of the axis
- Verriegelung der Achse

MADE IN HIGH QUALITY POLAND

**CHARIOT EXTENSIBLE POUR ÉLÉMENTS DE CARROSSERIE -
Extendable support - Ausziehbarer Wagen**

061507
max 150 kg
100 cm
26 kg
114.5 x 42 x 13.5 cm

MADE IN HIGH QUALITY POLAND

**CHARIOT DE LUXE MAROUFLAGE - Premium masking machine -
Abdeckpapier-Ständer**

MADE IN HIGH QUALITY POLAND

x 5
rouleaux de papier
- Papierständer
- Paper roll
30 > 120 cm

057333
150 x 133 x 62 cm
32 kg
152 x 17 x 29 cm

OPTION
Ø 40 mm
x 6
058897

**CHARIOT DE MAROUFLAGE - Masking machine -
Abdeckpapier-Ständer**

MADE IN HIGH QUALITY POLAND

x 3
rouleaux de papier
- Papierständer
- Paper roll
30, 60, 90 cm

056954
150 x 62 x 110 cm
- 12 kg
122 x 29 x 17 cm

**CHARIOT DE STOCKAGE - Storage trolley -
Lagerrollwagen**

040243

71 x 90 x 197cm
41 kg
x2:
90 x 6 x 147 cm
+ 97 x 74 x 24 cm

TIGES DE BLOCAGE - Flap Lock

056732

36 > 115 cm

**TABOURET - Round Stool with Tool Storage -
Werkstatt-Rollhocker**

057555
38 x 38 x 44 cm - 6 kg
40 x 40 x 18 cm

max : 50 cm
min : 38 cm

SERVANTE 3 PLATEAUX - Workstation 3 shelves

068056

65 kg max
65 kg max
65 kg max

835 mm
390 mm
800 mm

NEW

**CHARIOT DE VISITE - Mechanics Creeper with
Tilting Headrest - Werkstatt-Rollliege**

057548
102 x 43 x 11 cm
7.2 kg
11 x 44 x 13 cm

**MARCHE PIED - Folding Step Stool
(Aluminium) - Arbeitspodest klappbar**

ALU 200 kg

057562
8.2 kg
102 x 41 x 59 cm

960 mm
385 mm
475 mm

**CHARIOT POUR ÉLÉMENTS DE CARROSSERIE -
Universal support - Universelle Ständer**

066281
20 kg
max 80 kg
Ø 4.5 cm
80 cm
Ø 12.5
70-100 cm
115 cm

NEW

MADE IN HIGH QUALITY POLAND

ALU 150 kg

058552
15.5 kg
116 x 43 x 17 cm - 16.5 kg

1090 > 1750 mm
520 > 900 mm
300 mm

COUVERTURE ANTI-CHALEUR - Heat cover - Hitzeschutzdecke - Manta anti-calor - Protecção anti-aquecimento

PROTEC 550
550°C/1000°F - Class M0
2m x 2m - 580 g/m²
050495

PROTEC 1200
1200°C/2200°F - Class M0
1.75m x 1.5m - 1200 g/m²
050204

PROTEC 1300
1300°C/2400°F - Class M0
XL: 2m x 1.8m - 620 g/m²
053595

PROTEC 1300L
1300°C/2400°F
XL: 2m x 1.8m - 427 g/m²
060500

JEU DE 2 AIMANTS
- Set of 2 magnets -
Schweißmagnet

(x2)
052291

COUVERTURE MAGNÉTIQUE - Magnetic cover - Magnetschutzdecke

1.06 m x 0.6 m
061446

RIDEAU DE SOUDAGE - Welding curtain and frame - Schweißerschutzwand

OPTI 215.0
Orange CE - 2 x 2.15 m
EN 25980 - 2015/01
060470

OPTI 200G
Green T9 - 2 x 2 m
EN 25980 - 2015/01
060463

MASQUES RESPIRATOIRES - Respiratory masks - Atemschutzmaske - Máscaras respiratorias

FFP3 - EN 140 / EN 143 / EN 166
(x1) Size M/L
037021

FFP3 - EN 140 / EN 143
(x1) Size M/L
037014

Étui / Case
037045

FFP3 - EN 143 : 2000 P3
Anti poussières / Anti odeurs
037038

FFP1
(x20) EN 149-2001
043916

FFP2D-OV
M/L (x5) EN 149-2001
043923

LUNETTES DE PROTECTION
- Protection goggles - Schutzbrillen

EN 166

Shade/IR0
042810

Shade/IR0
042827

Shade/IR5
042841

Shade/IR0
047778

Shade/IR0
047792

Shade/IR0
042865

Shade/IR0
047839

GANTS - Gloves - Handschuhe - Guantes

Anti coupe - Anti-cut
T9
045897

✓ écran tactile - touch screen friendly

Anti coupe haute résistance
High resistance anti-cut
EN 420
EN 388:4121
T9: 045910
T10: 045927

EN388
4342

Anti coupe haute dextérité
High dexterity anti-cut
EN 420
EN 388:1121
T9: 045903
T10: 045934

T10
064188

EN420
2003

Ultra Flexible
EN388
2003

EN388
4244

EN 407
424X4X
EN12477
Class: A1

Heavy Duty T10
(MMA - MIG - Plasma)
045101

Cuir Leather
Gants PRO TIG
T10
045194

EN388
2122

EN 407
322X2X
EN12477
Class: A1

Cuir Leather
Gants PRO TIG EXTRA
T10
045323

EN388
2111XX

EN 407
423X4X
EN12477
Class: A1

TABLIER CUIR MULTI-USAGE
- Multi-use leather apron - Delantal
de cuero multi-uso - Mehrzweck-
Lederschürze

Cuir Leather
PRO
045217

ÉQUIPEMENTS POUR OPÉRATIONS SUR VÉHICULES ÉLECTRIQUES & HYBRIDES - Equipment for operations on electric and hybrid vehicles - Ausrüstung für den Betrieb von Elektro- und Hybridfahrzeugen

ÉCRAN FACIAL AVEC SERRE-TÊTE
- FACE SHIELD WITH HEADBAND
068018

NEW

GANTS ISOLANTS (T10)
- INSULATING GLOVES (T10)
068025

NEW

Coffret de 25 outils isolés 1000V - 25 pieces insulated tools 1000V - Box mit 25 isolierten Werkzeugen 1000V
066489

Douilles 7/8/10/12/14/15/17/19/22 mm - 7/8/10/12/14/15/17/19/22 mm sockets	x 9
Pince universelle de 175 mm en chrome vanadium - 175 mm universal pliers in chrome vanadium	x 1
Pince coupante 150 mm en chrome vanadium - Cutting pliers 150 mm in chrome vanadium	x 1
Cluqiet en 3/8" - 3/8" ratchet	x 1
Rallonge 100 mm - Extension 100 mm	x 1
Poignée en T - T-handle	x 1
Clés plates à fourches 7/8/10/12/14/17 mm - Open ended wrenches 7/8/10/12/14/17 mm	x 6
Couteau pour câble - Cable knife	x 1
Tournevis Philips PhH1x100/PhH2x100 mm - Phillips PhH1x100/PhH2x100 mm screwdriver	x 2
Tournevis plats 5.5x125/4x100 mm - Flat screwdriver 5.5x125 / 4x100 mm	x 2

Kit pour le balisage de la zone d'intervention
- Kit for marking the area of intervention - Kennzeichnungsset für Hochvolt-Bereiche
064409

Balise de signalisation rouge et blanche - Red and white warning pole	x 4
Chaîne de délimitation rouge et blanche - Red and white bounding line	x 1
Pancarte de signalisation "Danger, zone de travail VEH" - Sign board "Danger, working area EHV"	x 2

PANTALON - Trousers - Hose

98% cotton, 2% antistatic

EN ISO 11611 Class 2-A1 & A2

EN ISO 11612 A1+A2-B1-C1-E3-F1

IEC 61482-2 Class 1-4kA

EN 1149-5

EN 14404 +A1 Type 2

S (40/42) 046368

M (44/46) 046375

L (48/50) 046382

XL (52/54) 046399

XXL (56/58) 046412

VESTE - Jacket - Jacke

98% cotton, 2% antistatic

EN ISO 11612 A1+A2-B1-C1-E3-F1

EN ISO 11611 Class 2-A1 & A2

EN 1149-5

EN 14404 +A1 Type 2

S (40/42) 046313

M (44/46) 046320

L (48/50) 046337

XL (52/54) 046344

XXL (56/58) 046351

BSU & CHARGERS

BATTERY SUPPORT UNIT

Homologations Approvals Zulassungen APPROVED EQUIPMENT

A FULL RANGE FOR ALL NEEDS

NEW

CATALOGUE 2022

CHARGERS
6 - 12 - 24 - 36 - 48 V

STARTERS & CHARGERS
12 - 24 V

BOOSTERS
6 - 12 - 24 V

TESTERS
12 - 24 V

ACCESSORIES
+

MORE



A COMPLETE RANGE

for 200 > 240 V MONO / TRI
50/60 Hz

DÉBOSSÉLAGE - Dent pulling - デントプラー

SOUDURE PAR POINT - Spotwelding - スポット溶接

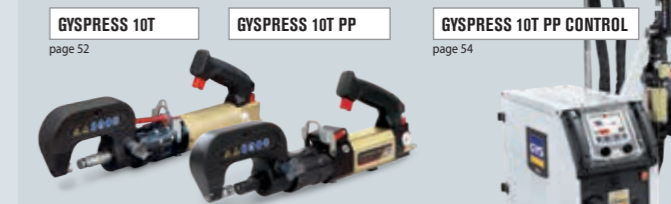
RIVETAGE - Riveting - リベット打ち

MIG/MAG TRADITIONNEL - Traditional MIG/MAG - ミグ/マグトラディショナル

MIG/MAG INVERTER PULSÉ - ミグ/マグパルスインバーター

CHARGEUR - Battery charger - バッテリーチャージャー

DÉCOUPAGE PLASMA - Plasma cutting - プラズマカッター

INDUCTION - インダクション

INDIAN CAR MANUFACTURER APPROVALS / COMPLIANCE

		OEM - CARS										OEM - TRUCKS				
DENT PULLER	GYSPT 39.02															
	SPEEDLINER															
	GYSPT ALU FV															
SPOT WELDERS	GYSPT 32D															
	GYSPT INVERTER BP-MS/LX/LC/LQC															
	GYSPT EVOLUTION PTI-s7															
MIG/MAG	CARMIG															
	T1 GYS AUTO															
	T3 GYS AUTO															
PLASMA	NEOPULSE															
	CUTTER 25K															
	CUTTER 30FV															
INDUCTION	GYSDUCTION AUTO															
BATTERY CHARGERS																
TOOLS & TROLLEYS																

INDIAN HOMOLOGATIONS
200 - 208 - 230 - 240 V TRI - 50/60 HZ



GYS FRANCE

HEADQUARTER

1 rue de la Croix des Landes
CS 54159
53941 Saint-Berthevin - Cedex
Laval - France
Tel +33 2 43 01 23 60
E-mail service.client@gys.fr



ZI, 134 bd des Loges
53941 Saint-Berthevin
Laval - France

LOGISTIC CENTER

2 Rue Jean Dausset
53910 Changé - France
Tel +33 2 43 01 54 33



INVEST IN THE FUTURE



French manufacturer
since 1964

INVEST IN THE FUTURE

www.gys.fr



GYS Germany

Professor-Wieler
Straße 11
52070 Aachen
Deutschland

Tel +49 241 / 189-23-710
Fax +49 241 / 189-23-719
E-mail aachen@gys.fr



GYS UK

Unit 3
Great Central Way
Rugby - Warwickshire
CV21 3XH
United Kingdom

Tel +44 1926 338 609
Fax +44 1926 429 764
E-mail uk@gys.fr



GYS ITALIA

Vega - Parco Scientifico Tecnologico
di Venezia
Via Delle Industrie, 25/4
30175 Marghera - VE
Italia

Tel +39 041 53 21 565
E-mail italia@gys.fr



GYS CHINA

Lot N°15
6666 bd Songze
201706 Qingpu Shanghai
China

Tel +86 6221 4461
Fax +86 5226 0067
www.gys-china.com.cn
E-mail contact@gys-china.com.cn

MARKETING

Podium de présentation
- Display stand
- Podest

PODIUM 2
A : 80 cm
B : 50 cm
C : 50 cm
063211

PODIUM 1
A : 45 cm
B : 50 cm
C : 50 cm
063204

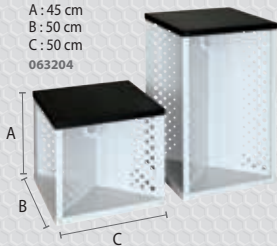

Linéaire de vente avec 2 étagères
- Retail display space with 2 shelves
- Lochwandregal mit 2 Böden
(machines not included)
060784



Barnum 3 x 3 m
098022

Open barnum
2 x 2 m
098039



Oriflamme
- Flag
1,75 x 0,50 m
098015

Distributed by

LinkedIn



Youtube



WeChat



exp. 095045

Pour signaler des erreurs dans le catalogue, contactez : catalogues@gys.fr. Document non contractuel. GYS se réserve le droit de modifier sans préavis les spécifications de ses appareils.
To report errors in the catalog, contact: catalogues@gys.fr. Document not contractual. GYS reserves the right to modify the specifications of the machines without prior notice. Irrtümer und Änderungen vorbehalten. • I.P. - 298 g

